

## [MS-GPIPSEC-Diff]:

# Group Policy: IP Security (IPsec) Protocol Extension

---

### Intellectual Property Rights Notice for Open Specifications Documentation

- **Technical Documentation.** Microsoft publishes Open Specifications documentation (“this documentation”) for protocols, file formats, data portability, computer languages, and standards support. Additionally, overview documents cover inter-protocol relationships and interactions.
- **Copyrights.** This documentation is covered by Microsoft copyrights. Regardless of any other terms that are contained in the terms of use for the Microsoft website that hosts this documentation, you can make copies of it in order to develop implementations of the technologies that are described in this documentation and can distribute portions of it in your implementations that use these technologies or in your documentation as necessary to properly document the implementation. You can also distribute in your implementation, with or without modification, any schemas, IDLs, or code samples that are included in the documentation. This permission also applies to any documents that are referenced in the Open Specifications documentation.
- **No Trade Secrets.** Microsoft does not claim any trade secret rights in this documentation.
- **Patents.** Microsoft has patents that might cover your implementations of the technologies described in the Open Specifications documentation. Neither this notice nor Microsoft's delivery of this documentation grants any licenses under those patents or any other Microsoft patents. However, a given Open Specifications document might be covered by the Microsoft [Open Specifications Promise](#) or the [Microsoft Community Promise](#). If you would prefer a written license, or if the technologies described in this documentation are not covered by the Open Specifications Promise or Community Promise, as applicable, patent licenses are available by contacting [iplg@microsoft.com](mailto:iplg@microsoft.com).
- **License Programs.** To see all of the protocols in scope under a specific license program and the associated patents, visit the [Patent Map](#).
- **Trademarks.** The names of companies and products contained in this documentation might be covered by trademarks or similar intellectual property rights. This notice does not grant any licenses under those rights. For a list of Microsoft trademarks, visit [www.microsoft.com/trademarks](http://www.microsoft.com/trademarks).
- **Fictitious Names.** The example companies, organizations, products, domain names, email addresses, logos, people, places, and events that are depicted in this documentation are fictitious. No association with any real company, organization, product, domain name, email address, logo, person, place, or event is intended or should be inferred.

**Reservation of Rights.** All other rights are reserved, and this notice does not grant any rights other than as specifically described above, whether by implication, estoppel, or otherwise.

**Tools.** The Open Specifications documentation does not require the use of Microsoft programming tools or programming environments in order for you to develop an implementation. If you have access to Microsoft programming tools and environments, you are free to take advantage of them. Certain Open Specifications documents are intended for use in conjunction with publicly available standards specifications and network programming art and, as such, assume that the reader either is familiar with the aforementioned material or has immediate access to it.

**Support.** For questions and support, please contact [dochelp@microsoft.com](mailto:dochelp@microsoft.com).

## Revision Summary

Date	Revision History	Revision Class	Comments
2/22/2007	0.01	New	Version 0.01 release
6/1/2007	1.0	Major	Updated and revised the technical content.
7/3/2007	2.0	Major	Updated and revised the technical content.
7/20/2007	2.0.1	Editorial	Changed language and formatting in the technical content.
8/10/2007	2.0.2	Editorial	Changed language and formatting in the technical content.
9/28/2007	2.0.3	Editorial	Changed language and formatting in the technical content.
10/23/2007	2.0.4	Editorial	Changed language and formatting in the technical content.
11/30/2007	2.0.5	Editorial	Changed language and formatting in the technical content.
1/25/2008	3.0	Major	Updated and revised the technical content.
3/14/2008	3.0.1	Editorial	Changed language and formatting in the technical content.
5/16/2008	3.0.2	Editorial	Changed language and formatting in the technical content.
6/20/2008	3.0.3	Editorial	Changed language and formatting in the technical content.
7/25/2008	4.0	Major	Updated and revised the technical content.
8/29/2008	5.0	Major	Updated and revised the technical content.
10/24/2008	5.1	Minor	Clarified the meaning of the technical content.
12/5/2008	5.1.1	Editorial	Changed language and formatting in the technical content.
1/16/2009	5.2	Minor	Clarified the meaning of the technical content.
2/27/2009	5.3	Minor	Clarified the meaning of the technical content.
4/10/2009	5.4	Minor	Clarified the meaning of the technical content.
5/22/2009	6.0	Major	Updated and revised the technical content.
7/2/2009	7.0	Major	Updated and revised the technical content.
8/14/2009	7.1	Minor	Clarified the meaning of the technical content.
9/25/2009	7.2	Minor	Clarified the meaning of the technical content.
11/6/2009	7.2.1	Editorial	Changed language and formatting in the technical content.
12/18/2009	8.0	Major	Updated and revised the technical content.
1/29/2010	8.1	Minor	Clarified the meaning of the technical content.
3/12/2010	9.0	Major	Updated and revised the technical content.
4/23/2010	10.0	Major	Updated and revised the technical content.
6/4/2010	10.1	Minor	Clarified the meaning of the technical content.
7/16/2010	11.0	Major	Updated and revised the technical content.

<b>Date</b>	<b>Revision History</b>	<b>Revision Class</b>	<b>Comments</b>
8/27/2010	12.0	Major	Updated and revised the technical content.
10/8/2010	13.0	Major	Updated and revised the technical content.
11/19/2010	14.0	Major	Updated and revised the technical content.
1/7/2011	15.0	Major	Updated and revised the technical content.
2/11/2011	16.0	Major	Updated and revised the technical content.
3/25/2011	17.0	Major	Updated and revised the technical content.
5/6/2011	18.0	Major	Updated and revised the technical content.
6/17/2011	18.1	Minor	Clarified the meaning of the technical content.
9/23/2011	19.0	Major	Updated and revised the technical content.
12/16/2011	20.0	Major	Updated and revised the technical content.
3/30/2012	20.0	None	No changes to the meaning, language, or formatting of the technical content.
7/12/2012	20.1	Minor	Clarified the meaning of the technical content.
10/25/2012	20.1	None	No changes to the meaning, language, or formatting of the technical content.
1/31/2013	20.1	None	No changes to the meaning, language, or formatting of the technical content.
8/8/2013	21.0	Major	Updated and revised the technical content.
11/14/2013	21.0	None	No changes to the meaning, language, or formatting of the technical content.
2/13/2014	21.1	Minor	Clarified the meaning of the technical content.
5/15/2014	21.1	None	No changes to the meaning, language, or formatting of the technical content.
6/30/2015	22.0	Major	Significantly changed the technical content.
10/16/2015	22.0	None	No changes to the meaning, language, or formatting of the technical content.
7/14/2016	22.0	None	No changes to the meaning, language, or formatting of the technical content.
6/1/2017	22.0	None	No changes to the meaning, language, or formatting of the technical content.
9/15/2017	23.0	Major	Significantly changed the technical content.
9/12/2018	24.0	Major	Significantly changed the technical content.
4/7/2021	25.0	Major	Significantly changed the technical content.
6/25/2021	26.0	Major	Significantly changed the technical content.

# Table of Contents

<b>1</b>	<b>Introduction</b>	<b>6</b>
1.1	Glossary	6
1.2	References	8
1.2.1	Normative References	8
1.2.2	Informative References	9
1.3	Overview	10
1.3.1	Background	10
1.3.2	IPsec Protocol Overview	10
1.4	Relationship to Other Protocols	13
1.5	Prerequisites/Preconditions	14
1.6	Applicability Statement	14
1.7	Versioning and Capability Negotiation	14
1.8	Vendor-Extensible Fields	14
1.9	Standards Assignments	15
<b>2</b>	<b>Messages</b>	<b>16</b>
2.1	Transport	16
2.2	Message Syntax	16
2.2.1	IPsec Policy Creation/Modification	16
2.2.1.1	ipsecPolicy Object Attribute Details	20
2.2.1.1.1	ipsecPolicy{GUID} Object Attribute Descriptions	21
2.2.1.2	ipsecISAKMPPolicy Object Attribute Details	23
2.2.1.2.1	ipsecISAKMPPolicy{GUID} Object Attribute Descriptions	24
2.2.1.3	ipsecNFA Object Attribute Details	31
2.2.1.3.1	ipsecNFA{GUID} Object Description	32
2.2.1.4	ipsecNegotiationPolicy Object Attribute Details	38
2.2.1.4.1	ipsecNegotiationPolicy{GUID} Object Description	39
2.2.1.5	ipsecFilter Object Attribute Details	44
2.2.1.5.1	ipsecFilter{GUID} Object Description	45
2.2.2	IPsec Policy Assignment	56
2.2.3	IPsec Policy Retrieval	57
2.2.3.1	Policy Location, Name, and Description Retrieval	58
2.2.3.2	Policy Data Retrieval	58
2.3	Directory Service Schema Elements	59
<b>3</b>	<b>Protocol Details</b>	<b>61</b>
3.1	IPsec Group Policy Administrative Plug-in Details	61
3.1.1	Abstract Data Model	61
3.1.2	Timers	61
3.1.3	Initialization	61
3.1.4	Higher-Layer Triggered Events	61
3.1.5	Message Processing Events and Sequencing Rules	62
3.1.5.1	Configuring an LDAP BindRequest	62
3.1.5.2	Terminating the LDAP BindRequest	62
3.1.5.3	Retrieving the Assigned Policy Location, Name, and Description	62
3.1.5.4	Reading the Assigned Policy Data	62
3.1.5.5	Writing the Assigned Policy Data	62
3.1.5.6	Modifying the Assigned Policy Data	64
3.1.5.7	Deleting the Assigned Policy Data	64
3.1.5.8	Policy Assignment	66
3.1.6	Timer Events	67
3.1.7	Other Local Events	67
3.2	IPsec Group Policy Client-Side Plug-in Details	67
3.2.1	Abstract Data Model	67
3.2.2	Timers	67

3.2.3	Initialization .....	67
3.2.4	Higher-Layer Triggered Events .....	68
3.2.4.1	Processing Group Policy Callbacks .....	68
3.2.5	Message Processing Events and Sequencing Rules .....	68
3.2.5.1	Locating a Domain Controller.....	68
3.2.5.2	Establishing a Connection to the Domain Controller .....	68
3.2.5.3	Retrieving the Assigned Policy Location, Name, and Description .....	69
3.2.5.4	Retrieving the Assigned Policy Data.....	69
3.2.6	Timer Events.....	70
3.2.6.1	Local Timer Expiration .....	70
3.2.7	Other Local Events.....	70
<b>4</b>	<b>Protocol Examples .....</b>	<b>71</b>
4.1	Administrative Creation/Assignment of Policy .....	71
4.1.1	Policy Creation .....	71
4.1.2	Policy Assignment.....	73
4.2	Client Retrieval of Policy.....	74
4.2.1	Retrieving the Assigned Policy Name, Description, and Location .....	74
4.2.2	Retrieving the Assigned Policy Data .....	74
<b>5</b>	<b>Security .....</b>	<b>78</b>
5.1	Security Considerations for Implementers .....	78
5.2	Index of Security Parameters .....	78
<b>6</b>	<b>(Updated Section) Appendix A: Product Behavior.....</b>	<b>79</b>
<b>7</b>	<b>Change Tracking.....</b>	<b>82</b>
<b>8</b>	<b>Index.....</b>	<b>83</b>

# 1 Introduction

The Group Policy: IP Security (IPsec) Protocol Extension is layered on top of the Group Policy: Core Protocol (as specified in [MS-GPOL]). The transmitted configuration data enables centralized (common) configuration of the IPsec component on multiple client systems to provide basic traffic filtering, data integrity, and optionally, data encryption for IP traffic.

Sections 1.5, 1.8, 1.9, 2, and 3 of this specification are normative. All other sections and examples in this specification are informative.

## 1.1 Glossary

This document uses the following terms:

**Active Directory:** The Windows implementation of a general-purpose directory service, which uses LDAP as its primary access protocol. Active Directory stores information about a variety of objects in the network such as user accounts, computer accounts, groups, and all related credential information used by Kerberos [MS-KILE]. Active Directory is either deployed as Active Directory Domain Services (AD DS) or Active Directory Lightweight Directory Services (AD LDS), which are both described in [MS-ADOD]: Active Directory Protocols Overview.

**authentication header (AH):** An Internet Protocol Security (IPsec) encapsulation mode that provides authentication and message integrity. For more information, see [RFC4302] section 1.

**binary large object (BLOB):** A collection of binary data stored as a single entity in a database.

**client-side extension GUID (CSE GUID):** A GUID that enables a specific client-side extension on the Group Policy client to be associated with policy data that is stored in the logical and physical components of a Group Policy Object (GPO) on the Group Policy server, for that particular extension.

**curly braced GUID string:** The string representation of a 128-bit globally unique identifier (GUID) using the form {XXXXXXXX-XXXX-XXXX-XXXX-XXXXXXXXXXXX}, where X denotes a hexadecimal digit. The string representation between the enclosing braces is the standard representation of a GUID as described in [RFC4122] section 3. Unlike a GUIDString, a curly braced GUID string includes enclosing braces.

**default response rule:** A rule that ensures that computers respond to requests for secure communication. If an active policy does not have a rule defined for a computer that is requesting secure communication, the default response rule is applied and security is negotiated.

**directory:** The database that stores information about objects such as users, groups, computers, printers, and the directory service that makes this information available to users and applications.

**directory string:** A string encoded in UTF-8 as defined in [RFC2252] section 6.10.

**distinguished name (DN):** A name that uniquely identifies an object by using the relative distinguished name (RDN) for the object, and the names of container objects and domains that contain the object. The distinguished name (DN) identifies the object and its location in a tree.

**domain:** A set of users and computers sharing a common namespace and management infrastructure. At least one computer member of the set must act as a domain controller (DC) and host a member list that identifies all members of the domain, as well as optionally hosting the Active Directory service. The domain controller provides authentication of members, creating a unit of trust for its members. Each domain has an identifier that is shared among its members. For more information, see [MS-AUTHSOD] section 1.1.1.5 and [MS-ADTS].

**Encapsulating Security Payload (ESP):** An Internet Protocol security (IPsec) encapsulation mode that provides authentication, data confidentiality, and message integrity. For more information, see [RFC4303] section 1.

**fully qualified domain name (FQDN):** An unambiguous domain name that gives an absolute location in the Domain Name System's (DNS) hierarchy tree, as defined in [RFC1035] section 3.1 and [RFC2181] section 11.

**globally unique identifier (GUID):** A term used interchangeably with universally unique identifier (UUID) in Microsoft protocol technical documents (TDs). Interchanging the usage of these terms does not imply or require a specific algorithm or mechanism to generate the value. Specifically, the use of this term does not imply or require that the algorithms described in [RFC4122] or [C706] must be used for generating the GUID. See also universally unique identifier (UUID).

**Group Policy:** A mechanism that allows the implementer to specify managed configurations for users and computers in an Active Directory service environment.

**Group Policy extension:** A protocol that extends the functionality of Group Policy. Group Policy extensions consist of client-side extensions and Administrative tool extensions. They provide settings and other Group Policy information that can be read from and written to Group Policy data store components. Group Policy Extensions depend on the Group Policy: Core Protocol, via the core Group Policy engine, to identify GPOs containing a list of extensions that apply to a particular Group Policy client.

**Group Policy Object (GPO):** A collection of administrator-defined specifications of the policy settings that can be applied to groups of computers in a domain. Each GPO includes two elements: an object that resides in the Active Directory for the domain, and a corresponding file system subdirectory that resides on the sysvol DFS share of the Group Policy server for the domain.

**Internet Key Exchange (IKE):** The protocol that is used to negotiate and provide authenticated keying material for security associations (SAs) in a protected manner. For more information, see [RFC2409].

**Internet Protocol security (IPsec):** A framework of open standards for ensuring private, secure communications over Internet Protocol (IP) networks through the use of cryptographic security services. IPsec supports network-level peer authentication, data origin authentication, data integrity, data confidentiality (encryption), and replay protection.

**Internet Security Association and Key Management Protocol (ISAKMP):** A cryptographic protocol specified in [RFC2408] that defines procedures and packet formats to establish, negotiate, modify and delete security associations (SAs). It forms the basis of the Internet Key Exchange (IKE) protocol, as specified in [RFC2409].

**IPsec administrative plug-in:** The Internet Protocol security (IPsec) extension plug-in that operates as part of the group policy configuration tool that reads and writes IPsec policy using the Group Policy: IP Security (IPsec) Protocol Extension [MS-GPIPSEC].

**IPsec client-side plug-in:** The Internet Protocol security (IPsec) extension plug-in that operates on the client machine to retrieve the policy using the Group Policy: IP Security (IPsec) Protocol Extension [MS-GPIPSEC].

**IPsec component:** The implementation of the Internet Protocol security (IPsec)/Internet Key Exchange (IKE) functionality on a client machine. This is the component that the Group Policy: IP Security (IPsec) Protocol Extension [MS-GPIPSEC] configures with the IPsec/IKE policy that is transferred as part of the protocol.

**main mode (MM):** The first phase of an Internet Key Exchange (IKE) negotiation that performs authentication and negotiates a main mode security association (MM SA) between the peers. For more information, see [RFC2409] section 5.

**negotiation filter association (NFA):** A term that is used to describe the logical binding together of the appropriate IPsec filter and IPsec negotiation policy settings for an IPsec policy.

**security association (SA):** A simplex "connection" that provides security services to the traffic carried by it. See [RFC4301] for more information.

**tool extension GUID or administrative plug-in GUID:** A GUID defined separately for each of the user policy settings and computer policy settings that associates a specific administrative tool plug-in with a set of policy settings that can be stored in a Group Policy Object (GPO).

**Transmission Control Protocol (TCP):** A protocol used with the Internet Protocol (IP) to send data in the form of message units between computers over the Internet. TCP handles keeping track of the individual units of data (called packets) that a message is divided into for efficient routing through the Internet.

**tunnel mode:** An IP encapsulation mechanism, as specified in [RFC4301], that provides Internet Protocol security (IPsec) security to tunneled IP packets. IPsec processing is performed by the tunnel endpoints, which can be (but are typically not) the end hosts.

**Unicode:** A character encoding standard developed by the Unicode Consortium that represents almost all of the written languages of the world. The Unicode standard [UNICODE5.0.0/2007] provides three forms (UTF-8, UTF-16, and UTF-32) and seven schemes (UTF-8, UTF-16, UTF-16 BE, UTF-16 LE, UTF-32, UTF-32 LE, and UTF-32 BE).

**User Datagram Protocol (UDP):** The connectionless protocol within TCP/IP that corresponds to the transport layer in the ISO/OSI reference model.

**MAY, SHOULD, MUST, SHOULD NOT, MUST NOT:** These terms (in all caps) are used as defined in [RFC2119]. All statements of optional behavior use either MAY, SHOULD, or SHOULD NOT.

## 1.2 References

Links to a document in the Microsoft Open Specifications library point to the correct section in the most recently published version of the referenced document. However, because individual documents in the library are not updated at the same time, the section numbers in the documents may not match. You can confirm the correct section numbering by checking the Errata.

### 1.2.1 Normative References

We conduct frequent surveys of the normative references to assure their continued availability. If you have any issue with finding a normative reference, please contact dochelp@microsoft.com. We will assist you in finding the relevant information.

[GSS] Piper, D., and Swander, B., "A GSS-API Authentication Method for IKE", Internet Draft, July 2001, <http://tools.ietf.org/html/draft-ietf-ipsec-isakmp-gss-auth-07>

[MS-ADA1] Microsoft Corporation, "Active Directory Schema Attributes A-L".

[MS-ADA2] Microsoft Corporation, "Active Directory Schema Attributes M".

[MS-ADA3] Microsoft Corporation, "Active Directory Schema Attributes N-Z".

[MS-ADSC] Microsoft Corporation, "Active Directory Schema Classes".

[MS-ADTS] Microsoft Corporation, "Active Directory Technical Specification".



[MS-DTYP] Microsoft Corporation, "Windows Data Types".

[MS-GPOL] Microsoft Corporation, "Group Policy: Core Protocol".

[MS-NRPC] Microsoft Corporation, "Netlogon Remote Protocol".

[RFC2119] Bradner, S., "Key words for use in RFCs to Indicate Requirement Levels", BCP 14, RFC 2119, March 1997, <http://www.rfc-editor.org/rfc/rfc2119.txt>

[RFC2251] Wahl, M., Howes, T., and Kille, S., "Lightweight Directory Access Protocol (v3)", RFC 2251, December 1997, <http://www.ietf.org/rfc/rfc2251.txt>

[RFC2254] Howes, T., "The String Representation of LDAP Search Filters", RFC 2254, December 1997, <http://www.ietf.org/rfc/rfc2254.txt>

[RFC2408] Maughan, D., Schertler, M., Schneider, M., and Turner, J., "Internet Security Association and Key Management Protocol (ISAKMP)", RFC 2408, November 1998, <http://www.ietf.org/rfc/rfc2408.txt>

[RFC2409] Harkins, D. and Carrel, D., "The Internet Key Exchange (IKE)", RFC 2409, November 1998, <http://www.ietf.org/rfc/rfc2409.txt>

[RFC2412] Orman, H., "The OAKLEY Key Determination Protocol", RFC 2412, November 1998, <http://www.ietf.org/rfc/rfc2412.txt>

### **1.2.2 Informative References**

[MSFT-ISOLATION-1] Microsoft Corporation, "Server and Domain Isolation Using IPsec and Group Policy", July 2006, <https://technet.microsoft.com/en-us/library/cc163159.aspx>

[MSFT-ISOLATION-2] Microsoft Corporation, "Setting Up IPsec Domain and Server Isolation in a Test Lab", June 2005, [https://technet.microsoft.com/en-us/library/cc782433\(v=ws.10\).aspx](https://technet.microsoft.com/en-us/library/cc782433(v=ws.10).aspx)

[MSFT-ISOLATION-3] Microsoft Corporation, "Active Directory Domain Services in the Perimeter Network (Windows Server 2008)", April 2009, [https://technet.microsoft.com/en-us/library/dd728034\(v=ws.10\).aspx](https://technet.microsoft.com/en-us/library/dd728034(v=ws.10).aspx)

[RFC2401] Kent, S. and Atkinson, R., "Security Architecture for the Internet Protocol", RFC 2401, November 1998, <https://tools.ietf.org/html/rfc2401>

[RFC2402] Kent, S. and Atkinson, R., "IP Authentication Header", RFC 2402, November 1998, <http://www.ietf.org/rfc/rfc2402.txt>

[RFC2406] Kent, S. and Atkinson, R., "IP Encapsulating Security Payload (ESP)", RFC 2406, November 1998, <http://www.ietf.org/rfc/rfc2406.txt>

[RFC2407] Piper, D., "The Internet IP Security Domain of Interpretation for ISAKMP", RFC 2407, November 1998, <http://www.ietf.org/rfc/rfc2407.txt>

[RFC2410] Glenn, R. and Kent, S., "The NULL Encryption Algorithm and Its Use With IPsec", RFC 2410, November 1998, <http://www.ietf.org/rfc/rfc2410.txt>

[RFC2411] Thayer, R., Doraswamy, N., and Glenn, R., "IP Security Document Roadmap", RFC 2411, November 1998, <http://www.ietf.org/rfc/rfc2411.txt>

[RFC3947] Kivinen, T., Swander, B., Huttunen, A., and Volpe, V., "Negotiation of NAT-Traversal in the IKE", RFC 3947, January 2005, <http://www.ietf.org/rfc/rfc3947.txt>

## 1.3 Overview

The Group Policy: IPsec Protocol allows administrators to arbitrarily instruct large groups of client machines to configure their local IPsec/IKE components to provide basic IP traffic filtering, IP data integrity, and optionally, IP data encryption.

This allows administrators to configure client machines to block, permit, or secure (using IPsec) IP traffic, which enables the configuration of IP network isolation, for example server isolation and domain isolation as described in [MSFT-ISOLATION-1].

### 1.3.1 Background

The Group Policy: Core Protocol as specified in [MS-GPOL] section 1.3, "Overview" allows clients to discover and retrieve policy settings that are created by administrators of a domain. These settings are persisted in Group Policy Objects (GPOs), which are assigned to "policy target" accounts in Active Directory. For IPsec configuration, policy target accounts are computer accounts in Active Directory. Each client uses the Lightweight Directory Access Protocol (LDAP) to determine what GPOs are applicable to it by consulting Active Directory objects that correspond to its computer account.

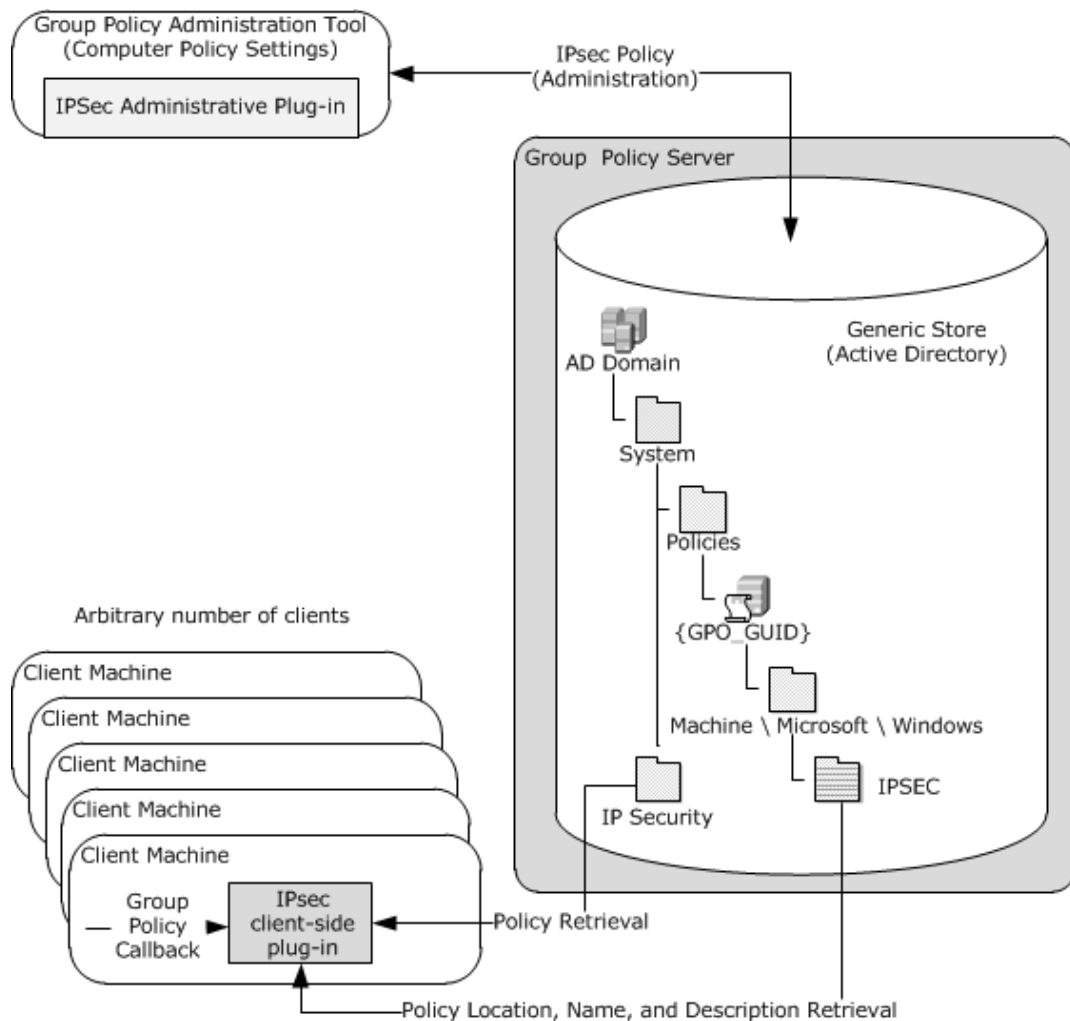
On each client, each GPO is interpreted and acted on by software components known as client-side plug-ins. The client-side plug-ins that are responsible for a specific GPO are specified by using an attribute on the GPO. This attribute specifies a list of GUID pairs. The first GUID of each pair is referred to as a client-side extension GUID (CSE GUID). The second GUID of each pair is referred to as a tool extension GUID.

For each GPO that is applicable to a client, the client consults the CSE GUIDs that are listed in the GPO to determine which client-side plug-ins on the client will handle the GPO. The client then invokes the client-side plug-ins to handle the GPO.

A client-side plug-in uses the contents of the GPO to retrieve class-specific settings in a manner that is specific to its class. After its class-specific settings are retrieved, the client-side plug-in uses those settings to perform class-specific processing.

### 1.3.2 IPsec Protocol Overview

The following figure shows the components that use the Group Policy: IPsec Protocol.



**Figure 1: Components that use the Group Policy: IPsec Protocol Extension**

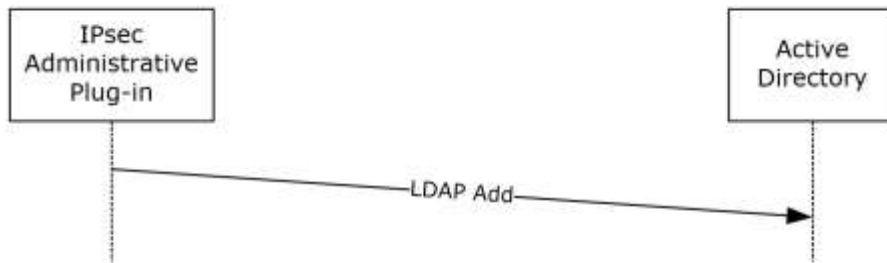
The components in the protocol are as follows:

- An IPsec administrative plug-in (computer policy settings) that is used to author and upload policy settings.
- A generic binary large object (BLOB) store with no protocol-specific knowledge (in this case, Active Directory).
- A client machine with an IPsec client-side plug-in.

The IPsec client-side plug-in locates the policy stores in the Active Directory store to retrieve policy information (see details in sections 3.2.5.1 and 3.2.5.3). Then, the IPsec client-side plug-in reads and applies policies, as specified in sections 3.2.5.1 and 3.2.5.4.

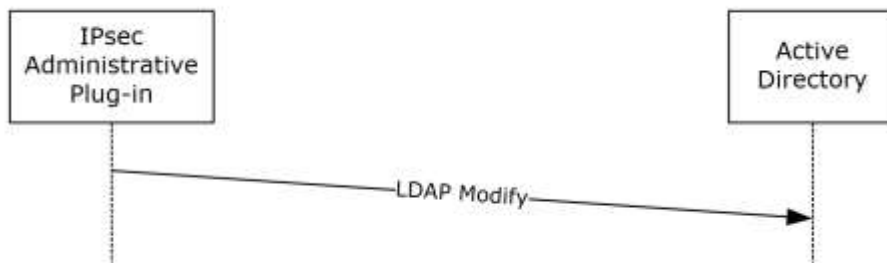
Policy information is authored in the IPsec administrative plug-in and is sent to a generic store (in this case, the Active Directory store). The policy data is generated by an IPsec policy administrator through an IPsec authoring user interface. The administrator creates one or more IPsec policies and assigns a single policy to a group of managed machines using a GPO.

The IPsec policy creation uses the LDAP "add" mechanism, as specified in [RFC2251] section 4.7. For details, see Message Syntax (section 2.2).



**Figure 2: IPsec policy creation**

The IPsec policy modification (for example, when changing an IPsec policy object name or reference GUID) uses the LDAP "modify" mechanism, as specified in [RFC2251] section 4.6. For details, see Message Syntax (section 2.2).



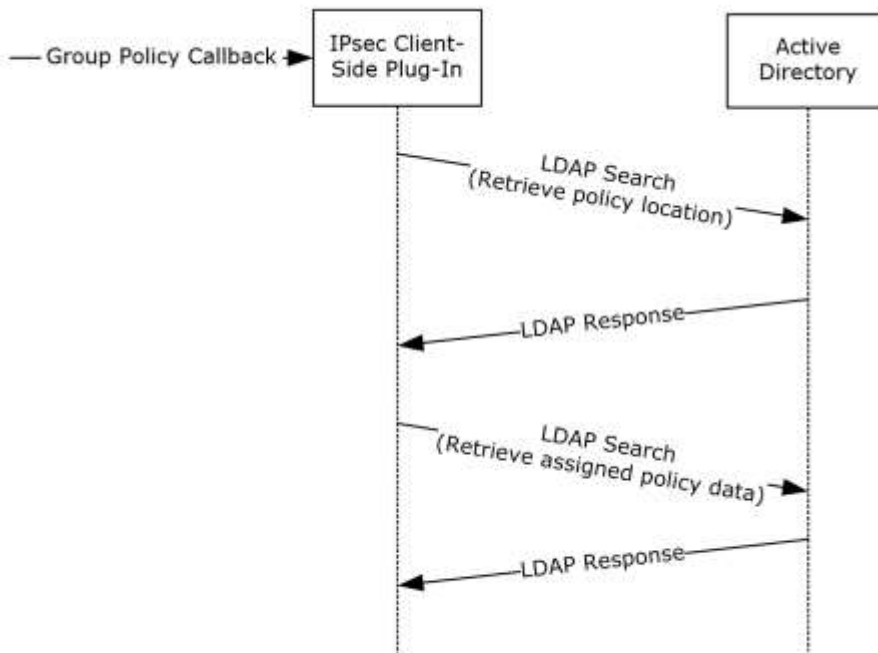
**Figure 3: IPsec policy modification**

A client obtains the IPsec policy in three steps:

1. A client-side Group Policy protocol client polls the store to discover the existence of a new policy. When a new or changed IPsec policy is detected, it signals the IPsec client-side plug-in that an IPsec policy change has occurred and provides an LDAP path to the assigned policy, as specified in [MS-GPOL] section 1.3.3.
2. The IPsec client-side plug-in reads the LDAP path that specifies the assigned policy location as an LDAP path reference that specifies the assigned IPsec policy details.
3. The IPsec policy detail LDAP path is then used by the IPsec client-side plug-in to read and interpret the assigned IPsec policy settings so that the IPsec policy settings can be enacted on the local system.

The details of the actual individual settings that are transferred by this protocol are specified in IPsec Policy Creation/Modification (section 2.2.1), because the relevant behavior is not part of the Group Policy: Core Protocol or its extensions, but rather of the Group Policy: IPsec Protocol. These details are included to enable a client to successfully read and interpret the IPsec policy data and understand the protocol.

IPsec policy retrieval uses the LDAP search functionality, as specified in [RFC2251] section 4.5, and in sections 3.2.5.3 and 3.2.5.4.



**Figure 4: IPsec policy retrieval**

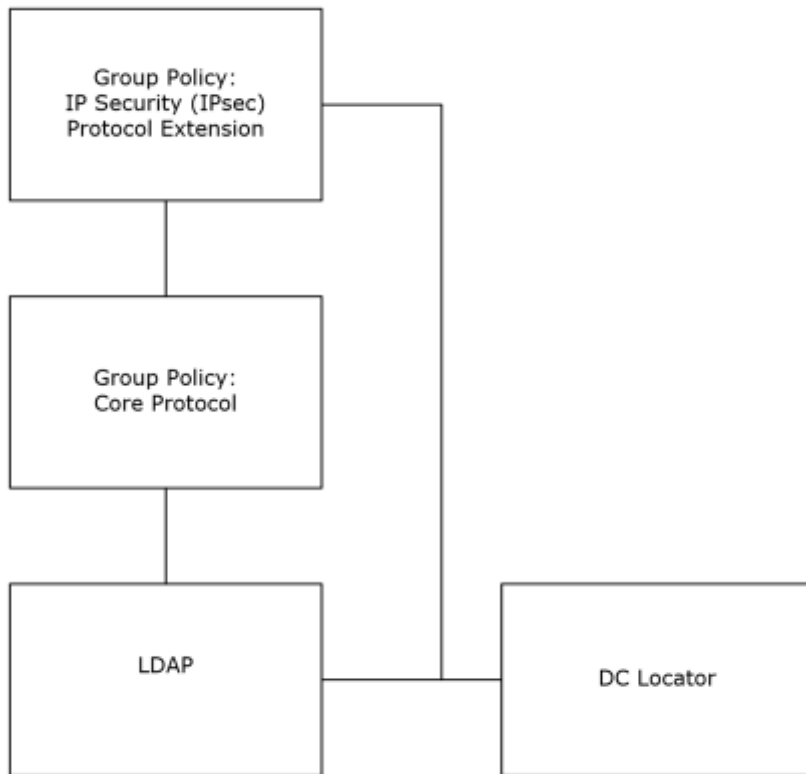
**Note** Processing instructions for the first LDAP Search/Response pair is specified in section 3.2.5.3. Processing instructions for the second LDAP Search/Response pair is specified in section 3.2.5.4.

#### 1.4 Relationship to Other Protocols

The Group Policy: IP Security (IPsec) Protocol Extension depends on the Group Policy: Core Protocol [MS-GPOL] to read and write IPsec policy ([RFC2401], [RFC2402], [RFC2406], [RFC2410], and [RFC2411]) on applicable Group Policy Objects (GPOs). The administrative plug-in for this protocol uses LDAP [RFC2251] to read and write protocol-specific data. The protocol also relies on the DC locator operation (see [MS-NRPC] section 3.5.4.3, "DC Location Methods") to locate a server from which to download the policy. These relationships are illustrated in this section.

The Group Policy IPsec Protocol Extension also uses the Internet Security Association and Key Management Protocol (ISAKMP), ([RFC2407] and [RFC2408]), OAKLEY ([RFC2412]), and Internet Key Exchange (IKE), as defined in [RFC2409] and [RFC3947].

The following figure illustrates the relationship of the Group Policy: IP Security (IPsec) Protocol Extension to other protocols and the DC locator process.



**Figure 5: Protocol relationship diagram**

### 1.5 Prerequisites/Preconditions

The prerequisites for this protocol are the same as for the Group Policy: Core Protocol, [MS-GPOL] section 1.5.

### 1.6 Applicability Statement

The Group Policy: IPsec Protocol is applicable only in the Group Policy framework. Data values that are interpreted differently depending on the implementation are noted in the specific data model descriptions. Systems receiving the policy data are required to ignore information that they do not understand.

### 1.7 Versioning and Capability Negotiation

There is no mechanism in the Group Policy: IPsec Protocol for versioning or capability negotiation. If new functionality is required that would be incompatible with the existing protocol, implement a new Group Policy protocol.

### 1.8 Vendor-Extensible Fields

None.

## 1.9 Standards Assignments

This protocol defines values for the IPsec client-side extension GUID and IPsec administrative extension GUID, as specified in [MS-GPOL] section 1.8, "Vendor-Extensible Fields". The assignments are as follows (note that the GUIDs are specified as their string representations).

Parameter	Value	Reference
IPsec administrative extension GUID (Computer Policy Settings)	{DEA8AFA0-CC85-11D0-9CE2-0080C7221EBD}	[MS-GPOL]
IPsec client-side extension GUID	{E437BC1C-AA7D-11D2-A382-00C04F991E27}	[MS-GPOL]

## 2 Messages

### 2.1 Transport

The Group Policy: IPsec Protocol uses the LDAP protocol, as specified in [RFC2251], to read and write data to the remote Active Directory data store.

### 2.2 Message Syntax

The messages are in the following three categories:

- IPsec policy creation/modification
- IPsec policy assignment
- IPsec policy retrieval

These categories are explained in the following subsections.

#### 2.2.1 IPsec Policy Creation/Modification

This section specifies how the IPsec Group Policy administrative plug-in creates and modifies an IPsec policy that is stored in Active Directory.

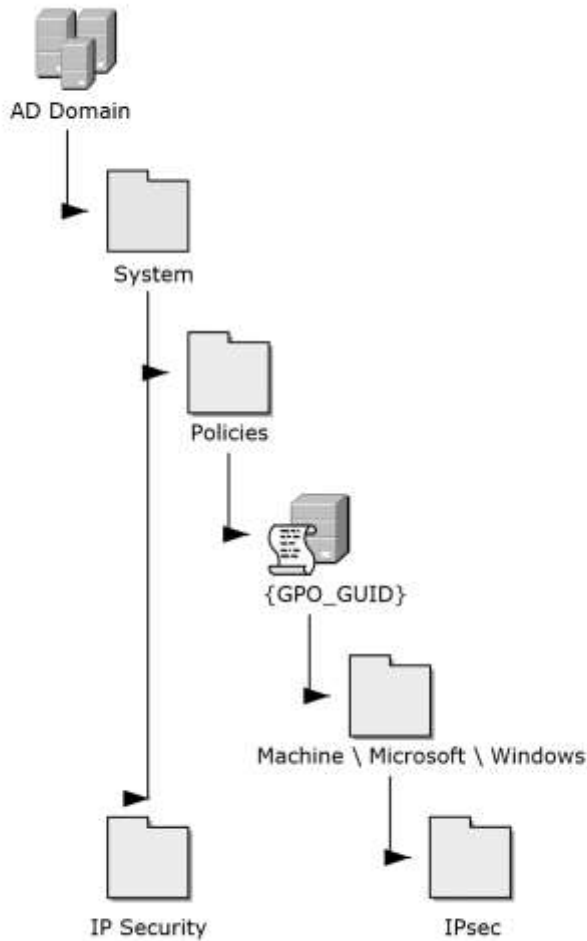
This section also provides background information that is needed to understand the storage of IPsec policy settings that are contained both within Group Policy Objects (GPOs) and the IPsec policy data that is contained within an IPsec-specific Active Directory data store. It also specifies how individual IPsec policy data items are written and modified in a generic policy store (in this case, Active Directory).

The following figure specifies the IPsec policy storage. IPsec policy storage deviates from the typical Group Policy storage mechanism as specified in [MS-GPOL] by storing the IPsec policy data separately from the GPO. The GPO contains a reference to the actual IPsec policy that is assigned to the policy target accounts, as specified in [MS-GPOL] section 1.3.3, "Policy Application".

An IPsec policy is created by writing the appropriate IPsec policy attributes to the "*System\IP Security*" container. The policy can then be assigned by writing a "reference" to the policy data in the "*System\Policies\GPO-GUID\Machine\Microsoft\Windows\IPSEC*" container. Note that the GPO\_GUID text MUST be replaced by a curly braced GUID string ([MS-DTYP] section 2.3.4.3, "GUID--Curly Braced String Representation") that identifies the GPO.

The reference of the policy that is assigned to a GPO MUST be stored in the "*Machine\Microsoft\Windows*" container in the IPSEC object of the GPO for this Group Policy protocol. IPsec Policy Assignment is specified in section 2.2.2.

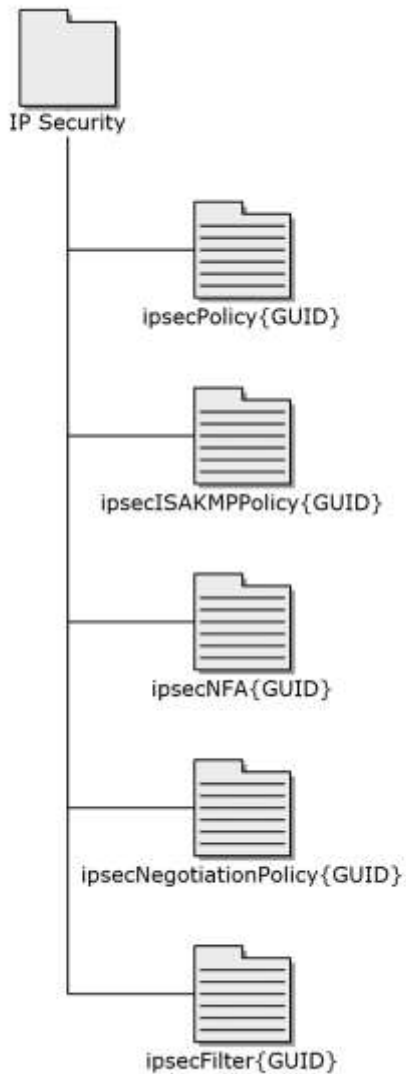




**Figure 6: IPsec policy storage**

The actual IPsec policy creation and modification protocol consists of writing a series of messages that create or modify the *ipsecPolicy*, *ipsecISAKMPPolicy*, *ipsecNFA*, *ipsecNegotiationPolicy*, and *ipsecFilter* entries (and the associated attributes as specified in [MS-ADSC] section 2.71, "Class ipsecFilter", [MS-ADSC] section 2.72, "Class ipsecISAKMPPolicy", [MS-ADSC] section 2.73, "Class ipsecNegotiationPolicy", [MS-ADSC] section 2.74, "Class ipsecNFA", and [MS-ADSC] section 2.75, "Class ipsecPolicy") to the "System\IP Security" container. IPsec policy creation uses 'addRequest' messages that conform with [RFC2251] section 4.1.1. IPsec policy modification uses 'modifyRequest' messages that conform with [RFC2251] section 4.1.1.

All attributes MUST be present and correctly formatted to specify an IPsec policy. There is no restriction on the order in which the values are written. The individual policy objects MUST be stored in the "IP Security" container, as the following figure shows.



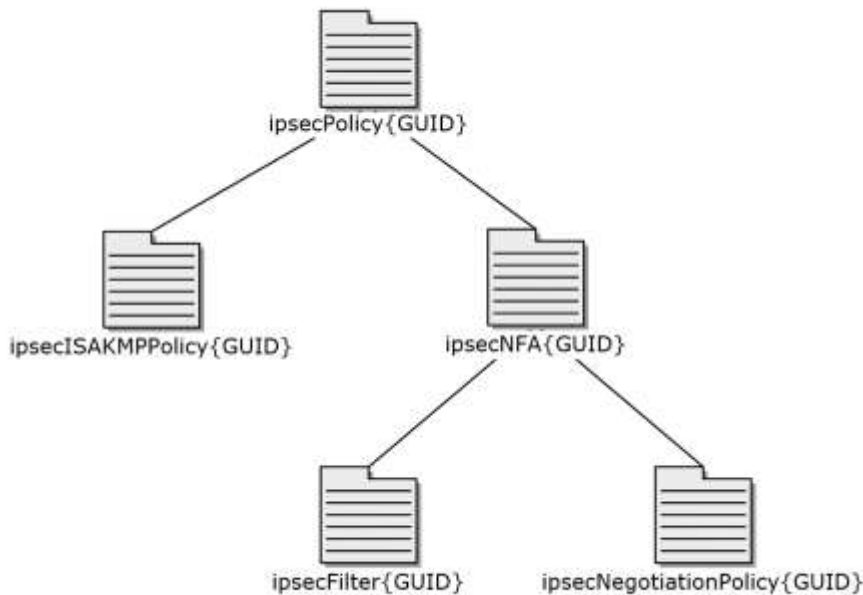
**Figure 7: Individual policy objects stored in the IP Security container**

IPsec policy creation MUST use the addRequest when adding the policy. The individual values are specified in the data descriptions that follow in sections 2.2.1.1, 2.2.1.2, 2.2.1.3, 2.2.1.4, and 2.2.1.5.

IPsec policy modification MUST use the "replace" operation of modifyRequest when writing policies to enable "update-to" values representing the policy. The individual values are specified in the data descriptions that follow in sections 2.2.1.1, 2.2.1.2, 2.2.1.3, 2.2.1.4, and 2.2.1.5.

The individual objects in a single policy MUST be organized into a logical hierarchy. The hierarchy is defined by individual data object attributes (as specified in sections 2.2.1.1, 2.2.1.2, 2.2.1.3, 2.2.1.4, and 2.2.1.5). A complete IPsec policy consists of five hierarchical data objects, as shown in the following figure. Each IPsec policy instance MUST have one of each policy type. The diagram depicts the required policy items and logical hierarchy.

The individual items are all stored in the "IP Security" container, and the relationships shown are logical, not physical. A logical relationship is formed by an attribute of one item having as a value the name of another item.

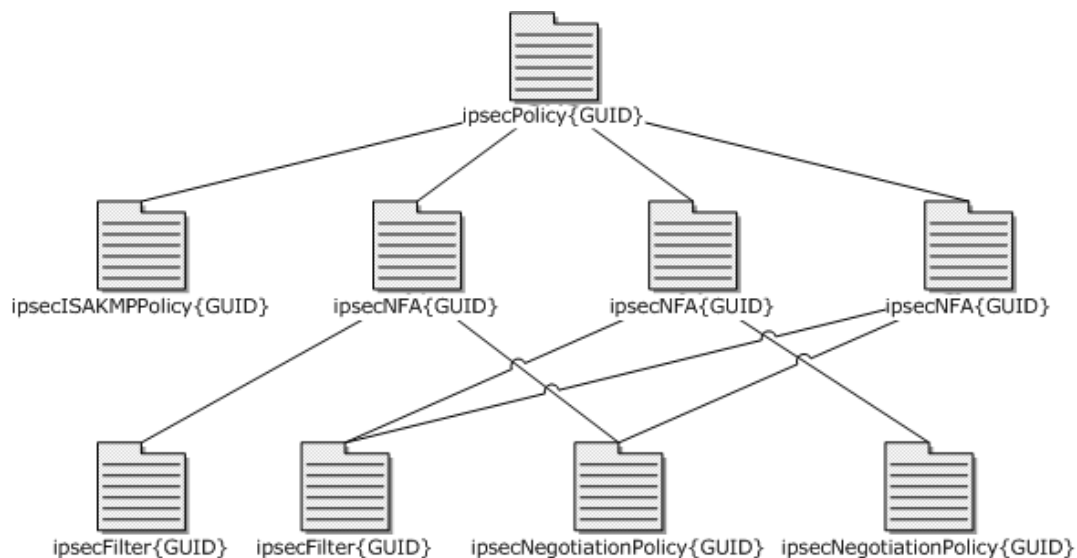


**Figure 8: Required policy items and logical hierarchy for a complete IPsec policy**

To create a complete IPsec policy, object creation and modification can be implemented in the following order:

1. Create ipsecPolicy.
2. Create ipsecISAKMPPolicy.
3. Create ipsecNFA.
4. Create ipsecNegotiationPolicy.
5. Create ipsecFilter.
6. Modify ipsecPolicy - with ipsecISAKMPReference ipsecNFAResource.
7. Modify ipsecNFA - with ipsecFilterReference ipsecNegotiationPolicyReference.

**Note** In practice, the policy structure might not be as simple as the preceding diagram suggests because multiple ipsecNFA objects can (and usually do) exist per ipsecPolicy. For example, consider two ipsecFilter objects, two ipsecNegotiationPolicy objects, and three different ipsecNFA objects. In this example, these objects are denoted as F1, F2; NegPol1, NegPol2; and NFA1, NFA2, and NFA3 respectively. Note that NFA1 can reference F1 and NegPol1, and NFA2 can reference F2 and NegPol2. Then, a single ipsecPolicy can reference both NFA1 and NFA2. These relationships are illustrated in the following figure.



**Figure 9: Multiple ipsecNFA objects per ipsecPolicy**

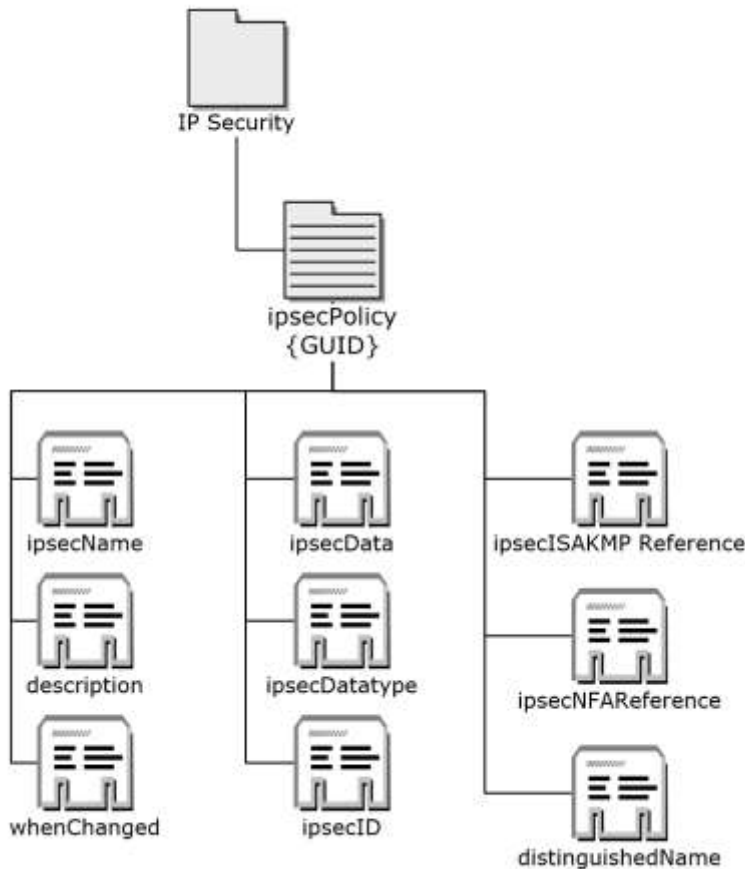
**Note** Multiple ipsecPolicy objects can be stored in the "IP Security" container. Separate policies (ipsecPolicy objects) are often assigned as active policy to particular GPOs, so that a specific IPsec policy can be applied to a group of machines that have a common need.

The following explains the cardinality of object associations:

- Each ipsecPolicy object can be associated to one or more ipsecNFA objects. Each ipsecNFA object can be associated to a maximum of one ipsecPolicy object.
- Each ipsecISAKMPPolicy object can be associated to one ipsecPolicy object. Each ipsecPolicy object can be associated to a maximum of one ipsecISAKMPPolicy object.
- Each ipsecNegotiationPolicy object can be associated to zero or more ipsecNFA objects. Each ipsecNFA object can be associated to a maximum of one ipsecNegotiationPolicy object.
- Each ipsecFilter object can be associated to zero or more ipsecNFA objects. Each ipsecNFA object can be associated to one or more ipsecFilter objects.

### 2.2.1.1 ipsecPolicy Object Attribute Details

IPsec policy is the main unit of a single policy instance. The **ipsecPolicy** data attribute contains this IPsec policy information. It **MUST** contain a reference to an ISAKMP policy, at least one reference to a negotiation filter association (NFA) policy, and other miscellaneous IPsec policy settings. The following figure shows an IPsec policy object.



**Figure 10: IPsec policy object**

IPsec policy creation MUST use the LDAP add functionality in conformance with [RFC2251] section 4.7.

IPsec policy modification MUST use the LDAP modify functionality in conformance with [RFC2251] section 4.6.

### 2.2.1.1.1 ipsecPolicy{GUID} Object Attribute Descriptions

The following table specifies the attributes of the ipsecPolicy class object (as specified in [MS-ADSC], [MS-ADA1], and [MS-ADA3]).

The types used in the following (and subsequent) tables are defined as follows: "LDAPString" as defined in [RFC2251] section 4.1.2; "UTC Coded String" defined as an LDAPString containing the generalized time syntax of the form YYYYMMDDHHMMSS[.fraction][(+|-HHMM)|Z], where Z means UTC; "Distinguished Name" as defined in [RFC2251] section 4.1.3; and "Octet String" as defined in [RFC2251] section 4.1.2.

Name	Type	Description
objectClass	LDAPString	The Directory String that contains the object class. A typical value is "ipsecPolicy". This attribute is only used during policy creation.
ipsecName	LDAPString	The user-constructed Directory String that contains the name for this

Name	Type	Description
		policy. A typical value is "Secure Server Policy".
description	LDAPString	The user-constructed Directory String that is intended to contain a description of the policy. A typical value is "Policy to secure corporate network traffic".
whenChanged	UTC-coded string	The Unicode generalized time syntax of the time and date the policy was last changed. This value is set by the Active Directory server.
ipsecID	LDAPString	A Directory String containing the curly braced GUID string value of this ipsecPolicy object. A typical value is like the following: "{6A1E5C3F-72B7-11D2-ACF0-0260B025CAFE}".
distinguishedName	Distinguished name	The Directory String description of the directory location of this policy. This MUST be in the distinguished name (DN) format of [RFC2251]. This MUST be set by the protocol. A typical value is like the following: "CN=ipsecPolicy{6A1E5C3F-72B7-11D2-ACF0-0260B025CAFE },CN=IP Security,CN=System,DC=myDomain,DC=contoso,DC=com".
ipsecISAKMPReference	Distinguished name	The Directory String reference to the ipsecISAKMPPolicy object that is associated with this policy. This MUST be in the DN format of [RFC2251]. A typical value is like the following: "CN=ipsecISAKMPPolicy{6A1E5C3F-72B7-11D2-ACF0-0260B025CAFE }, CN=IP Security,CN=System, DC=myDomain, DC=contoso,DC=com". This attribute is not used during ipsecPolicy creation; it is only used during modification.
ipsecNFAReference	A list of distinguished names	A list of Directory String references to the ipsecNFA objects that are associated with this ipsecPolicy object. The list MUST be composed of DNs in the format specified in [RFC2251]. The separator between two DNs is 2 bytes of 0. For example: DN1-2bytesof0-DN2, where DN1 and DN2 are distinguished names. There can be multiple NFA references present; each NFA reference is a NULL-terminated DN. A typical value is like the following: "CN=ipsecNFA{6A1E5C3F-72B7-11D2-ACF0-0260B025CAFE },CN=IP Security, CN=System,DC=myDomain, DC=contoso,DC=com". This attribute is not used during policy creation; it is only used during policy modification.
ipsecDataType	LDAPString	The identifier that describes the format of the following ipsecData attribute. This MUST be the base-10 Directory String representation of the unsigned integer value 0x100 (256).
ipsecData	Octet string	The octet string representation of the binary data that specifies additional policy data stored as described in the following ipsecData-specific table.

The following table specifies the contents of the ipsecData attribute.

Note that all fields specified in the following tables MUST appear in little-endian byte order.

0	1	2	3	4	5	6	7	8	9	0	1	2	3	4	5	6	7	8	9	0	1	2	3	4	5	6	7	8	9	0	1
IPsec_Policy_ID (16 bytes)																															
...																															
...																															

Data-Length	
Polling-Interval	
Unused	

**IPsec\_Policy\_ID (16 bytes):** The identifier that specifies this as describing the policy. This MUST be the GUID whose string representation is "{22202163-4f4c-11d1-863b-00a0248d3021}".

**Data-Length (4 bytes):** The length, in bytes, of the following data. This MUST be the unsigned integer value 0x00000004.

**Polling-Interval (4 bytes):** The number of seconds that the client waits before polling the IPsec Active Directory store to see if there have been any policy changes. This MUST be an unsigned integer value. Polling interval is 10,800 seconds when this value is set to 0.

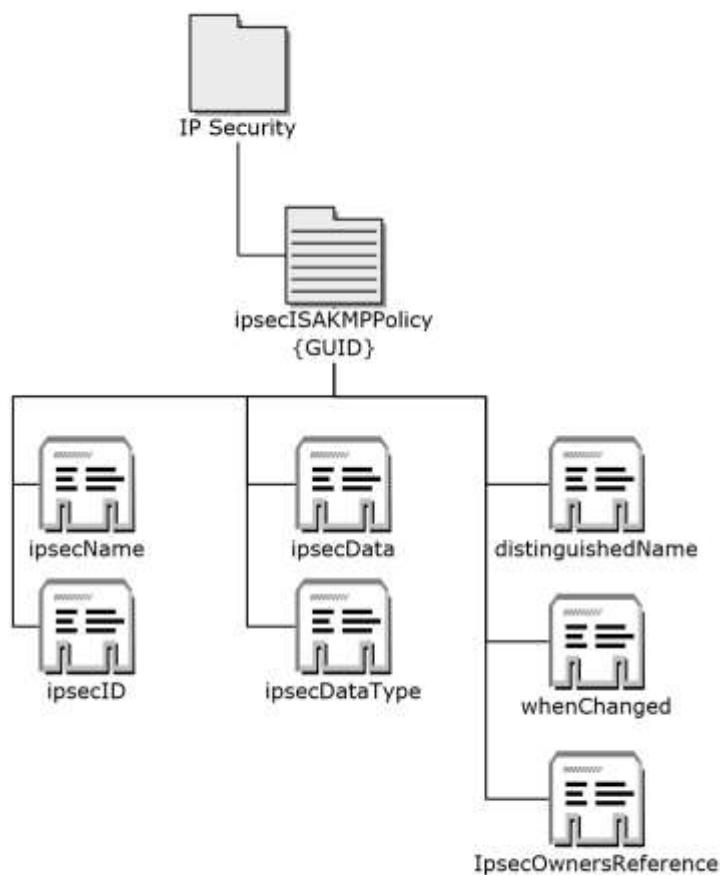
**Unused (1 byte):** This value MUST always be written as 0x0 and MUST be ignored when read.

### 2.2.1.2 ipsecISAKMPPolicy Object Attribute Details

The ISAKMP policy stores information related to the initial IPsec conversation (that is, main mode (MM); as defined in [RFC2408] and [RFC2409], section 7.1). The **ipsecISAKMPPolicy** data attribute contains this ISAKMP policy information.

The ISAKMP policy includes settings for establishing a security association (SA) and cryptographic keys with a remote peer. It also stores IKE settings that it uses to exchange keys with the IPsec peer.

The following diagram shows the ISAKMP policy object.



**Figure 11: ISAKMP policy object**

The **ipsecISAKMPPolicy** object creation MUST use the LDAP add functionality in conformance with [RFC2251] section 4.7.

The **ipsecISAKMPPolicy** object modification MUST use the LDAP modify functionality in conformance with [RFC2251] section 4.6.

The **ipsecISAKMPPolicy** attributes are specified in the following subsection.

### 2.2.1.2.1 ipsecISAKMPPolicy{GUID} Object Attribute Descriptions

The following table specifies the attributes of the ipsecISAKMPPolicy class object (as specified in [MS-ADSC], [MS-ADA1], and [MS-ADA3]).

Name	Type	Description
objectClass	LDAPString	The Directory String that contains the object class. A typical value is "ipsecISAKMPPolicy". This attribute is only used during policy creation.
ipsecName	LDAPString	The ipsecName attribute for ipsecISAKMPPolicy objects. This MUST NOT be set to NULL.<1>
whenChanged	UTC-coded string	The Unicode-generalized time syntax of the time and date that the policy was last changed. This value is set by the Active Directory server.



Name	Type	Description
ipsecID	LDAPString	This MUST be a Directory String containing the curly braced GUID string value of this ipsecISAKMPPolicy object. A typical value is "{6A15C3F-72B7-11D2-A3F0-0260B025CAFE}".
distinguishedName	Distinguished name	This MUST be a Directory String description of the directory location of this ISAKMP policy. This MUST be in the distinguished name (DN) format of [RFC2251]. This MUST be set by the protocol. A typical value is "CN=ipsecISAKMPPolicy{6A1E5C3F-72B7-11D2-ACF0-0260B025CAFE},CN=IP Security,CN= System,DC=myDomain,DC=contoso,DC=com".
ipsecOwnersReference	Distinguished name	This MUST be a Directory String reference (DN) to the "owner" IPsec policy object with which this ISAKMP object is associated. This MUST be in the DN format of [RFC2251]. A typical value is "CN=ipsecPolicy{6A45C3F-72B7-11D2-ACF0-0260B025CAFE},CN=IP Security,CN= System,DC=myDomain,DC=contoso,DC=com".
ipsecDataType	LDAPString	The identifier that describes the format of the following <b>ipsecData</b> attribute. This MUST be the base-10 Directory String representation of the unsigned integer value 0x100 (256).
ipsecData	Octet string	The octet string representation of the binary data that specifies additional policy data; stored as described in the following <b>ipsecData</b> -specific table.

**Note** The ipsecISAKMPPolicy object ([MS-ADSC] section 2.72, "Class ipsecISAKMPPolicy") as specified in LDAP messages, is encoded using BER, as defined in [RFC2251] section 5.1.

The following table specifies the **ipsecData** attribute-specific sections, corresponding names, and data types for the assigned values for the purpose of IPsec policy configuration.

The values of these settings MUST NOT be interpreted by this protocol; that is, they are to be applied as is to the IPsec component, which can interpret them independently of the protocol or mechanism that was used to configure them. A description of the interpretation by the IPsec component is provided for informative purposes (as opposed to the syntax, which is normative).

Note that all fields specified in the following tables MUST appear in little-endian byte order.

0	1	2	3	4	5	6	7	8	9	0	1	2	3	4	5	6	7	8	9	0	1	2	3	4	5	6	7	8	9	0	1
ISAKMP-Policy-Type-ID (16 bytes)																															
...																															
...																															
Data-Length																															
ISAKMP-Policy-Instance (16 bytes)																															
...																															
...																															
Zero1																															

Master-PFS-Required			
ISAKMP-Options			
New-DH-1	New-DH-2	New-DH-3	New-DH-4
QM-Limit			
MM-Lifetime			
Zero2 (20 bytes)			
...			
...			
Security-Method-Count			
Security-Methods (variable)			
...			

**ISAKMP-Policy-Type-ID (16 bytes):** The identifier that specifies this as an ISAKMP policy; MUST be the GUID whose string representation is "{80DC20B8-2EC8-11D1-A89E-00A0248D3021}".

**Data-Length (4 bytes):** This field MUST be the length, in bytes, of the following data minus 1. This MUST be an unsigned integer. This field is always 1 byte less than the size of the following data encoded as an octet stream.

**ISAKMP-Policy-Instance (16 bytes):** This MUST be the GUID value of this ipsecISAKMPPolicy object. This MUST be a 128-bit GUID value.

**Zero1 (4 bytes):** This value MUST always be written as 0x00000000 and MUST be ignored when read.

**Master-PFS-Required (4 bytes):** Indicates whether IKE, as defined in [RFC2408], is to use master perfect forward secrecy (PFS) as defined in [RFC2409], sections 3.3 and 8. Master PFS configures the number of times a master key or its base keying material can be reused to generate the session key to one time only. It MUST be one of the following values.

Value	Meaning
0x00000000	No, master PFS is not required.
0x00000001	Yes, master PFS is required.

**ISAKMP-Options (4 bytes):** The policy specification modifiers applied to the ISAKMP policy, defined in [RFC2408] that IKE enacts. This field MUST be one of the following values.

Value	Meaning
0x00000000	No policy modifier.
0x00000001	When performing X.509 certificate authentication, the authentication MUST only be allowed if the certificate "Subject Alternate Name" can be mapped to a Kerberos authentication system

Value	Meaning
	identity (also known as certificate-mapping).
0x00000002	When performing X.509 certificate negotiation, do not send the peer the certificate request payload (CRP).
0x00000003	Perform X.509 certificate mapping (as per value 0x00000001 shown in the second row) and do not send the peer the CRP (as per value 0x00000002 shown in the third row).

**New-DH-1 (1 byte):** A nonzero value in the **New-DH-1** field is first in the order of precedence for the main mode (MM) offers used by IKE. If the value in this field is zero, byte-fields **New-DH-2**, **New-DH-3**, and **New-DH-4** is also set to zero. MM offers set on **Security-Methods** are appended to the **New-DH-1**, **New-DH-2**, **New-DH-3**, and **New-DH-4** fields. The **New-DH-1** field SHOULD<2> be one of the following values.

Value	Meaning
0x00	The field is not used.
0x01	The ISAKMP policy setting is Encryption:DES; Integrity:MD5; Diffie-Hellman:DH-2048.
0x02	The ISAKMP policy setting is Encryption:DES; Integrity:SHA-1; Diffie-Hellman:DH-2048.
0x03	The ISAKMP policy setting is Encryption:3DES; Integrity:MD5; Diffie-Hellman:DH-2048.
0x04	The ISAKMP policy setting is Encryption:3DES; Integrity:SHA-1; Diffie-Hellman:DH-2048.

**New-DH-2 (1 byte):** A nonzero value in the **New-DH-2** field is second in the order of precedence for the MM offers used by IKE. If the value in this field is zero, byte-fields **New-DH-3** and **New-DH-4** are also set to zero. MM offers set on **Security-Methods** are appended to the **New-DH-1**, **New-DH-2**, **New-DH-3**, and **New-DH-4** fields. The **New-DH-2** field SHOULD<3> be one of the following values.

Value	Meaning
0x00	This field is not used.
0x01	The ISAKMP policy setting is Encryption:DES; Integrity:MD5; Diffie-Hellman:DH-2048.
0x02	The ISAKMP policy setting is Encryption:DES; Integrity:SHA-1; Diffie-Hellman:DH-2048.
0x03	The ISAKMP policy setting is Encryption:3DES; Integrity:MD5; Diffie-Hellman:DH-2048.
0x04	The ISAKMP policy setting is Encryption:3DES; Integrity:SHA-1; Diffie-Hellman:DH-2048.

**New-DH-3 (1 byte):** A nonzero value in the **New-DH-3** field is third in the order of precedence for the MM offers used by IKE. If the value in this field is zero, byte-field **New-DH-4** is also set to zero. MM offers set on **Security-Methods** are appended to the **New-DH-1**, **New-DH-2**, **New-DH-3**, and **New-DH-4** fields. The **New-DH-3** field SHOULD<4> be one of the following values.

Value	Meaning
0x00	This field is not used.
0x01	The ISAKMP policy setting is Encryption:DES; Integrity:MD5; Diffie-Hellman:DH-2048.
0x02	The ISAKMP policy setting is Encryption:DES; Integrity:SHA-1; Diffie-Hellman:DH-2048.
0x03	The ISAKMP policy setting is Encryption:3DES; Integrity:MD5; Diffie-Hellman:DH-2048.

Value	Meaning
0x04	The ISAKMP policy setting is Encryption:3DES; Integrity:SHA-1; Diffie-Hellman:DH-2048.

**New-DH-4 (1 byte):** A nonzero value in the **New-DH-4** field is fourth in the order of precedence for the MM offers used by IKE. MM offers set on **Security-Methods** are appended to the **New-DH-1**, **New-DH-2**, **New-DH-3**, and **New-DH-4** fields. The **New-DH-4** field SHOULD<5> be one of the following values.

Value	Meaning
0x00	This field is not used.
0x01	The ISAKMP policy setting is Encryption:DES; Integrity:MD5; Diffie-Hellman:DH-2048.
0x02	The ISAKMP policy setting is Encryption:DES; Integrity:SHA-1; Diffie-Hellman:DH-2048.
0x03	The ISAKMP policy setting is Encryption:3DES; Integrity:MD5; Diffie-Hellman:DH-2048.
0x04	The ISAKMP policy setting is Encryption:3DES; Integrity:SHA-1; Diffie-Hellman:DH-2048.

The table that follows illustrates how the MM precedence order works. An X in a table cell denotes that a field has a value and a hyphen (-) indicates a value of zero.

New-DH-1	New-DH-2	New-DH-3	New-DH-4	Security-Method-1	...	Security-Method-N	Resultant order of MM precedence
X	X	X	X	X	...	X	New-DH-1 New-DH-2 New-DH-3 New-DH-4 Security-Method-1 ... Security-Method-N
X	X	X	-	X	...	X	New-DH-1 New-DH-2 New-DH-3 Security-Method-1 ... Security-Method-N
X	X	-	-	X	...	X	New-DH-1 New-DH-2 Security-Method-1 ... Security-Method-N
X	-	-	-	X	...	X	New-DH-1 Security-Method-1 ... Security-Method-N
-	-	-	-	X	...	X	Security-Method-1 ... Security-Method-N

**QM-Limit (4 bytes):** The number of quick modes allowed per main mode in an IKE ([RFC2409]) negotiation. A special value is 0x00000000, which means no limit. This field MUST be an unsigned integer.

**MM-Lifetime (4 bytes):** The maximum allowed main-mode key lifetime, in seconds, that IKE uses. A special value is 0x00000000, which means the main-mode key lifetime is set to 28,800 seconds. This field MUST be an unsigned integer.

**Zero2 (20 bytes):** This value MUST always be written as a 20-byte field that is filled with 0x00 and MUST be ignored when read.

**Security-Method-Count (4 bytes):** This MUST be the number of security-method BLOBs that follow. This field MUST be an unsigned integer.

**Security-Methods (variable):** The ISAKMP security methods, as specified in the following binary representation. There can be any number of these. The number is specified by the preceding Security-Method-Count field. This field is a multiple of 64 bytes.

0	1	2	3	4	5	6	7	8	9	10	11	12	13	14	15	16	17	18	19	20	21	22	23	24	25	26	27	28	29	30	31
Major-Version								Minor-Version								Zero3															
Encryption-Algorithm-ID																															
...																															
Zero4																															
Hash-Algorithm-ID																															
...																															
Zero5																															
Zero6																															
...																															
Random-Function								Zero7																							
...																															
Oakley-Group																															
QM-Limit																															
Oakley-Lifetime-KB																															
Oakley-Lifetime-Secs																															
PFS-Identity-Required																															

**Major-Version (1 byte):** The crypto bundle major version; MUST be 0x00.

**Minor-Version (1 byte):** The crypto bundle minor version; MUST be 0x00.

**Zero3 (2 bytes):** This value MUST always be written as 0x0000 and MUST be ignored when read.

**Encryption-Algorithm-ID (8 bytes):** The encryption algorithm that IKE uses. This MUST be one of the following values.

Value	Meaning
0x0000000000000000	None
0x0000000000000001	DES-CBC
0x0000000000000002	3DES-CBC
0x0000000000000003	3DES-CBC

**Zero4 (4 bytes):** This value MUST always be written as 0x00000000 and MUST be ignored when read.

**Hash-Algorithm-ID (8 bytes):** The hash algorithm that IKE uses. This MUST be one of the following values.

Value	Meaning
0x0000000000000000	None
0x0000000000000001	MD5
0x0000000000000002	SHA-1

**Zero5 (4 bytes):** This value MUST always be written as 0x00000000 and MUST be ignored when read.

**Zero6 (8 bytes):** This value MUST always be written as an 8-byte field that is filled with 0x00 and MUST be ignored when read.

**Random-Function (1 byte):** Overrides the values of Encryption-Algorithm-ID, Hash-Algorithm-ID, and Oakley-Group as follows. In addition, QM-Limit, MM-Lifetime, and Master-PFS-Required values from the policy object are used.

Value	Encryption-Algorithm-ID	Hash-Algorithm-ID	Oakley-Group
0x01	DES	MD5	Group-14
0x02	DES	SHA	Group-14
0x03	3DES	MD5	Group-14
0x04	3DES	SHA	Group-14

**Zero7 (7 bytes):** This value MUST always be written as a 7-byte field that is filled with 0x00 and MUST be ignored when read.

**Oakley-Group (4 bytes):** The Diffie-Hellman group that IKE uses, as defined in [RFC2412]. This MUST be one of the following values.

Value	Meaning
0x00000000	This field is not used.
0x00000001	Group-1
0x00000002	Group-2
0x10000001	Group-14

**QM-Limit (4 bytes):** The number of quick modes allowed per main mode in an IKE negotiation, as defined in [RFC2412] and [RFC2409]. A special value is 0x00000000, which means no limit. This field MUST be an unsigned integer.

**Oakley-Lifetime-KB (4 bytes):** The lifetime, in kilobytes, that IKE is to negotiate. This field MUST be an unsigned integer.

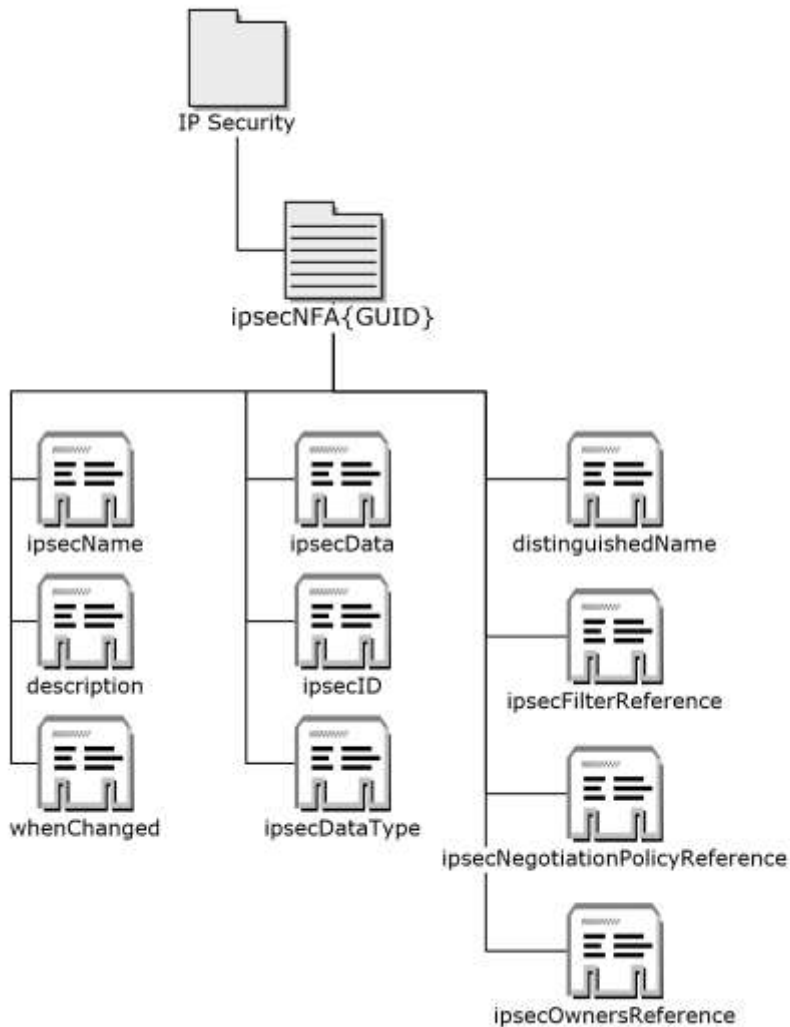
**Oakley-Lifetime-Secs (4 bytes):** The lifetime, in seconds, that IKE is to negotiate. This field MUST be an unsigned integer.

**PFS-Identity-Required (4 bytes):** Indicates whether IKE is to use PFS, as defined in [RFC2409]. Configures the number of times a master key or its base keying material can be reused to generate the session key to one time only. This MUST be one of the following values.

Value	Meaning
0x00000000	No, PFS Identity is not required.
0x00000001	Yes, PFS identity is required.

### 2.2.1.3 ipsecNFA Object Attribute Details

The NFA policy stores references to a Filter List policy and a Negotiation policy to bind the individual Filter and Negotiation policy objects together. The **ipsecNFA** data attribute contains this policy binding information. It also stores additional IPsec settings, such as authentication methods and tunnel mode configuration. The following diagram shows an NFA policy object.



**Figure 12: NFA policy object**

The **ipsecNFA** object creation MUST use the LDAP add functionality in conformance with [RFC2251] section 4.7.

The **ipsecNFA** object modification MUST use the LDAP modify functionality in conformance with [RFC2251] section 4.6.

The **ipsecNFA** attributes are specified in in the following subsection.

### 2.2.1.3.1 ipsecNFA{GUID} Object Description

The following table specifies the attributes of the ipsecNFA class object, as specified in [MS-ADSC], [MS-ADA1], and [MS-ADA3].

Name	Type	Description
<b>objectClass</b>	LDAPString	The Directory String that contains the object class. A typical value is



Name	Type	Description
		"ipsecNFA". This attribute is only used during policy creation.
<b>ipsecName</b>	LDAPString	The user-constructed Directory String that contains the name for this filter group. A typical value is "All Traffic filters".
<b>description</b>	LDAPString	The user-constructed Directory String that is intended to contain a description of the filter group. A typical value is "Me to Any filters".
<b>whenChanged</b>	UTC-coded string	The Unicode-generalized time syntax of the time and date that the policy was last changed. This value is set by the Active Directory server.
<b>ipsecID</b>	LDAPString	The Directory String that contains the curly braced GUID string value of this <b>ipsecNFA</b> object. A typical value looks like "{6A1E5C3F-72B7-11D2-ACF0-02603625CAFE}".
<b>distinguishedName</b>	Distinguished name	The Directory String description of the directory location of the NFA policy object. This MUST be in the DN format of [RFC2251]. This MUST be set by the protocol. A typical value is "CN=ipsecNFA{6A1E5C3F-72B7-11D2-ACF0-0260B025CAFE },CN=IP Security,CN=System,DC=myDomain,DC=contoso,DC=com".
<b>ipsecFilterReference</b>	Distinguished name	The Directory String reference to the ipsecFilter object that is associated with this filter list. This MUST be in the DN format of [RFC2251]. If multiple filters are associated with this NFA, this filter is one of them.  Other associated filters can be found by analyzing the ipsecOwnersReference of the filter. A typical value is "CN=ipsecFilter{6A1E5C3F-72B7-11D2-ACF0-0260B025CAFE },CN=IP Security, CN=System, DC=myDomain, DC=contoso, DC=com".  This attribute is not used during policy creation; it is only used during policy modification.
<b>ipsecNegotiationPolicy Reference</b>	Distinguished name	The Directory String reference to the single ipsecNegotiationPolicy object that is associated with this filter list policy. This MUST be in the DN format of [RFC2251]. A typical value is "CN=ipsecNegotiationPolicy{6A1E5C3F-72B7-11D2-ACF0-0260B025CAFE },CN=IP Security,CN=System, DC=myDomain, DC=contoso, DC=com".  This attribute is not used during policy creation; it is only used during policy modification.
<b>ipsecOwnersReference</b>	Distinguished name	The Directory String reference to the owner IPsec policy object with which this NFA object is associated. This MUST be in the DN format of [RFC2251]. A typical value is "CN=ipsecPolicy{6A1E5C3F-72B7-11D2-ACF0-0260B025CAFE },CN=IP Security, CN=System, DC=myDomain, DC=contoso,DC=com".
<b>ipsecDataType</b>	LDAPString	The identifier that describes the format of the following ipsecData attribute; this MUST be the Directory String representation of the unsigned integer value 0x100.
<b>ipsecData</b>	Octet string	The octet string representation of the binary data that specifies additional policy data that is stored as described in the following ipsecData-specific table.

**Note** The **ipsecNFA** object as specified in LDAP messages ([MS-ADSC], section 2.74, "Class ipsecNFA") is encoded using BER, as defined in [RFC2251] section 5.1.

The following table specifies the ipsecData attribute's specific sections, corresponding names, and the data types for the assigned values for the purpose of IPsec policy configuration.

The values of these settings MUST be applied as is to the IPsec component; they MUST NOT be interpreted by this protocol. The IPsec component that later interprets these settings is independent of the protocol or mechanism that is used to configure them. The syntax of these settings is normative, but a description of the IPsec component interpretation is provided for informative purposes only.

Note that all fields specified in the following tables MUST appear in little-endian byte order.

0	1	2	3	4	5	6	7	8	9	10	11	12	13	14	15	16	17	18	19	20	21	22	23	24	25	26	27	28	29	30	31
NFA-Policy-ID (16 bytes)																															
...																															
...																															
Data-Length																															
Auth-Method-Count																															
Auth-Methods (variable)																															
...																															
Interface-Type																															
Interface-Name-Length																															
Interface-Name (variable)																															
...																															
Tunnel-Address																															
Is-Tunnel-Specifier																															
Is-Active-Specifier																															
Tunnel-End-Point-Name-Length																															
Tunnel-End-Point-Name (variable)																															
...																															
Alt-Auth-Method-Id1 (16 bytes, optional)																															
...																															
...																															

Alt-Auth-Num-Methods-Count (optional)
Alt-Auth-Method-Data (variable)
...
Alt-Auth-Method-Id2 (16 bytes, optional)
...
...
Zero1
Alt-Auth-Method-Flags (variable)
...
IPv6-Tunnel-Mode-ID (16 bytes)
...
...
IPv6-Tunnel-Mode-Address (16 bytes)
...
...

**NFA-Policy-ID (16 bytes):** The identifier that specifies this BLOB as an NFA policy describing the policy; this MUST be the GUID whose string representation is "{11BBAC00-498D-11D1-8639-00A0248D3021}".

**Data-Length (4 bytes):** This MUST be the length, in bytes, of the data that follows up to and including Tunnel-End-Point-Name. The data beyond Tunnel-End-Point-Name is not accounted for in the **Data-Length** field. This MUST be an unsigned integer value. This field is always 1 byte less than the size of the following data encoded as an octet stream.<6>

**Auth-Method-Count (4 bytes):** This MUST be the number of Auth-Method binary values that follow. This MUST be an unsigned integer value.

**Auth-Methods (variable):** The binary data that specifies additional policy data. The length of this data is determined by the **Auth-Method-Count** field value and the **Auth-Method** data structure length; more specifically, the **Auth-Method** data structure repeats **Auth-Method-Count** times.

The following binary format specifies the contents of the **Auth-Method** structure.

0	1	2	3	4	5	6	7	8	9	1	0	1	2	3	4	5	6	7	8	9	2	0	1	2	3	4	5	6	7	8	9	3	0	1
Auth-Type																																		

Auth-Length
Auth-Method-Data (variable)
...

**Auth-Type (4 bytes):** The type of authentication that IKE performs for the NFA policy, as defined in [RFC2409] and [GSS]. This field **MUST** be one of the following values.

Value	Meaning
0x00000001	Authenticate by using a pre-shared key (PSK).
0x00000003	Authenticate by using an X.509 certificate.
0x00000005	Authenticate by using the Kerberos authentication system.

**Auth-Length (4 bytes):** This **MUST** be the length, in bytes, of the following **Auth-Method-Data** field. This **MUST** be an unsigned integer.

**Auth-Method-Data (variable):** The specific details of the Auth-Type that IKE uses, as defined in [GSS]. This **MUST** be one of the following values, based on the value of Auth-Type. It is recommended that the **Auth-Method-Data** be privacy protected (encrypted) to ensure that it is not susceptible to eavesdropping. This is particularly important for the pre-shared key value because it is not protected by a hash.

Auth-Type value	Auth-Method-Data value and meaning
0x00000001	Pre-shared key. The null-terminated Unicode text string to use for the pre-shared key (PSK) authentication.
0x00000003	X.509 certificate. The Unicode text string certificate name of the X.509 certificate to use to authenticate.<7>
0x00000005	Kerberos. The <b>Auth-Method-Data</b> field <b>MUST</b> be 0x0000.

**Interface-Type (4 bytes):** The type of interface to which the IPsec component **MUST** apply the NFA policy. This **MUST** be one of the following values.

Value	Meaning
0xFFFFFFFF	Apply to dial-up interfaces only.
0xFFFFFFFFE	Apply to LAN interfaces only.
0xFFFFFFFFD	Apply to all interfaces.

**Interface-Name-Length (4 bytes):** An unsigned integer that **MUST** be the length, in bytes, of the following **Interface-Name** field.

**Interface-Name (variable):** The Unicode string that names a particular interface.

**Tunnel-Address (4 bytes):** This MAY<8> be the IPv4 IP address of the IPsec tunnel mode endpoint to which the IPsec component will apply this NFA policy (if applicable). The **Is-Tunnel-Specifier** field indicates whether this field is to be interpreted by the IPsec component.

**Is-Tunnel-Specifier (4 bytes):** An indicator that this NFA policy applies to an IPsec tunnel. Used by IKE to negotiate SAs. This MUST be one of the following values.

Value	Meaning
0x00000000	This NFA is not a tunnel filter.
0x00000001	This filter is a tunnel filter.

**Is-Active-Specifier (4 bytes):** An indicator that this NFA policy is active and part of a policy. This MUST be one of the following values.

Value	Meaning
0x00000000	This NFA is not active.
0x00000001	This filter is active.

**Tunnel-End-Point-Name-Length (4 bytes):** This MUST be the length, in bytes, of the **Tunnel-End-Point-Name** field. This MUST be an unsigned integer.

**Tunnel-End-Point-Name (variable):** The Unicode string that names the tunnel mode endpoint (if applicable). This is applicable if the **Is-Tunnel-Specifier** field indicates that this is a tunnel, and the **Tunnel-End-Point-Name-Length** field indicates that this field has data.

**Alt-Auth-Method-Id1 (16 bytes):** This is an optional field that specifies this BLOB as an alternate authentication method. This SHOULD<9> be the GUID whose string representation is "{01010101-0101-0101-0101-01010101}". If the GUID is specified, **Alt-Auth-Num-Methods-Count** and **Alt-Auth-Method-Data** are also specified.

**Alt-Auth-Num-Methods-Count (4 bytes):** This is an optional field that SHOULD<10> specify the number of alternate authentication methods that follow. This value MUST be equal to **Auth-Method-Count** field.

**Alt-Auth-Method-Data (variable):** This optional field SHOULD<11> be the binary data that specifies additional authentication method policy data. The length of this data is determined by the **Alt-Auth-Num-Methods-Count** value and the Alt-Auth-Method-Data structure length. This data structure repeats for the value of **Alt-Auth-Num-Methods-Count**. The following binary format specifies the contents of this field.

0	1	2	3	4	5	6	7	8	9	10	11	12	13	14	15	16	17	18	19	20	21	22	23	24	25	26	27	28	29	30	31
Alt-Auth-Type (optional)																															
Alt-Auth-Method-Length (optional)																															
Alt-Auth-Method-Value (variable)																															
...																															

**Alt-Auth-Type (4 bytes):** This optional field<12> is the type of authentication to perform for the NFA policy. This MUST be one of the following values:

Value	Meaning
0x00000001	Authenticate by using a pre-shared key (PSK).

Value	Meaning
0x00000003	Authenticate by using an X.509 certificate.
0x00000005	Authenticate by using the Kerberos authentication system.

**Alt-Auth-Method-Length (4 bytes):** This is an optional field. This field is the length, in bytes, of the following **Alt-Auth-Method-Value** field. This field SHOULD<13> be an unsigned integer.

**Alt-Auth-Method-Value (variable):** An optional field, containing the specific details of the **Auth-Type** field. This SHOULD<14> be one of the following values.

Value	Meaning
0x00000001	Pre-shared key. The null-terminated Unicode text string to use for the pre-shared key (PSK) authentication. For example, "Open-Sesame".
0x00000003	X.509 certificate. The Unicode text string certificate name of the X.509 certificate to use to authenticate.<15>
0x00000005	Kerberos. The <b>Auth-Method-Data</b> field MUST be 0x00.

**Alt-Auth-Method-Id2 (16 bytes):** This is an optional field. The identifier that specifies this BLOB as an alternate authentication method; This SHOULD<16> be the GUID whose string representation is "{01010101-0101-0101-0101-01010102}". If the GUID is specified, the **Alt-Auth-Method-Flags** is specified.

**Zero1 (4 bytes):** This value MAY be filled with 0x00 and MUST be ignored when read.

**Alt-Auth-Method-Flags (variable):** This is an optional field that occurs **Alt-Auth-Num-Methods-Count** number of times. The length of this field is **Alt-Auth-Num-Methods-Count** \* 4 bytes. If the **Alt-Auth-Method-Value** is an X.509 certificate, this field describes the behavior of the certificate. This field SHOULD<17> be one of the following values.

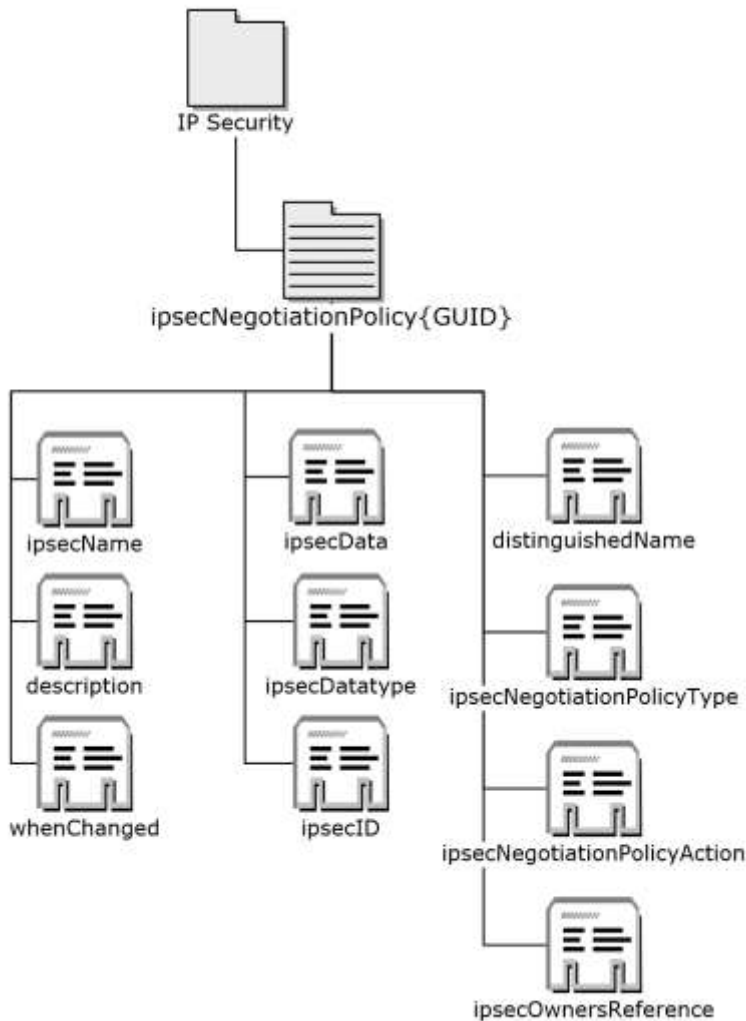
Value	Meaning
0x00000000	Auth method is not a certificate.
0x00000001	Enable certificate to account mapping.
0x00000002	Exclude CA name from certificate request.

**IPv6-Tunnel-Mode-ID (16 bytes):** The identifier that specifies this NFA contains an optional IPv6 address for the tunnel endpoint. If this field is present, it supersedes the (IPv4) **Tunnel-Address** field value. This SHOULD<18> be the GUID whose string representation is "{01010101-0101-0101-0101-01010103}".

**IPv6-Tunnel-Mode-Address (16 bytes):** This SHOULD<19> be the IPv6 address of the IPsec tunnel mode endpoint to which the IPsec component will apply this NFA (if applicable).

### 2.2.1.4 ipsecNegotiationPolicy Object Attribute Details

The Negotiation policy stores information regarding what action to take when it is determined that a packet matches the associated Filter policy. The **ipsecNegotiationPolicy** data attribute contains this Negotiation policy information. The actions are block, allow, and secure. It also includes security settings on how to secure the connection (also known as quick mode). The following diagram shows a Negotiation policy object.



**Figure 13: Negotiation policy object**

The **ipsecNegotiationPolicy** object creation MUST use the LDAP add functionality in conformance with [RFC2251] section 4.7.

The **ipsecNegotiationPolicy** object modification MUST use the LDAP modify functionality in conformance with [RFC2251] section 4.6.

The **ipsecNegotiationPolicy** attributes are specified in the following subsection.

#### 2.2.1.4.1 ipsecNegotiationPolicy{GUID} Object Description

The following table specifies the attributes of the **ipsecNegotiationPolicy** class object, as specified in [MS-ADSC], [MS-ADA1], and [MS-ADA3].

Name	Type	Description
<b>objectClass</b>	LDAPString	The Directory String that contains the object class. A typical value is like the following: "ipsecNegotiationPolicy". This

Name	Type	Description
		attribute is only used during policy creation.
<b>ipsecName</b>	LDAPString	The ipsecName attribute for ipsecNegotiationPolicy objects. This MUST NOT be set to NULL.<20>
<b>Description</b>	LDAPString	The user-constructed Directory String that is intended to contain a description of the negotiation policy. A typical value is like the following: "Secure the traffic with ESP(3DES)".
<b>whenChanged</b>	UTC-coded string	The Unicode-generalized time syntax of the time and date that the policy was last changed. This value is set by the Active Directory server.
<b>ipsecID</b>	LDAPString	The Directory String that contains the curly braced GUID string value of this ipsecNegotiationPolicy object. A typical value is like the following: "{6A1E5C3F-72B7-11d2-ACF0-02603625CAFE}".
<b>distinguishedName</b>	Distinguished name	The Directory String description of the directory location (DN) of this Negotiation policy object. This MUST be set by the protocol. A typical value is like the following: "CN=ipsecNegotiationPolicy{6A1E5C3F-72B7-11D2-ACF0-0260B025CAFE },CN=IP Security,CN=System,DC=myDomain,DC=contoso,DC=com".
<b>ipsecNegotiationPolicyAction</b>	LDAPString	The Directory String of the GUID that represents the policy action that needs to be taken based on a filter. For more information, see the following ipsecNegotiationPolicyAction table. A typical value is like the following: "{3F91A819-7647-11D1-864D-D46A00000000}".
<b>ipsecNegotiationPolicyType</b>	LDAPString	The Directory String of the GUID that represents the filter action type profile to use when interpreting the policy. For more information, see the following ipsecNegotiationPolicyType table. A typical value is like the following: "{62F49E10-6C37-11D1-864C-14A300000000}".
<b>ipsecOwnersReference</b>	List of distinguished names	A list composed of Directory String references to the owner ipsecNFA objects that are associated with this Negotiation policy object. The list MUST be composed of DNs in the format of [RFC2251]. The separator between two DNs is 2 bytes of '0'. For example: DN1 2bytesof0 DN2, where DN1 and DN2 are distinguished names.
<b>ipsecDataType</b>	LDAPString	The identifier that describes the format of the following <b>ipsecData</b> attribute. This MUST be the Directory String representation of the unsigned integer value 0x100.
<b>ipsecData</b>	Octet string	The octet string representation of the binary data that specifies additional policy data stored, as described in the following <b>ipsecData</b> -specific table.

**Note** The **ipsecNegotiationPolicy** object as specified in LDAP messages ([MS-ADSC], section 2.73, "Class ipsecNegotiationPolicy") is encoded using BER, as defined in [RFC2251] section 5.1.

The following tables specify the **ipsecNegotiationPolicyType**, **ipsecNegotiationPolicyAction**, and **ipsecData** attribute-specific sections, corresponding names, and the data types for the assigned values for the purpose of IPsec policy configuration.

The values of these settings MUST NOT be interpreted by this protocol; that is, they are applied as is to the IPsec component, which can interpret them independently of the protocol or mechanism that



was used to configure them. A description of the interpretation by the IPsec component is provided for informative purposes (as opposed to the syntax, which is normative).

**ipsecNegotiationPolicyType:** The **ipsecNegotiationPolicyType** value description. The value MUST be one of the following.

Value	Meaning
{62F49E13-6C37-11D1-864C-14A3-00000000}	This Negotiation policy is to use the default response rule action type for SA negotiation.
{62F49E10-6C37-11D1-864C-14A3-00000000}	This is a standard negotiation type; that is, it is not a default response.

**ipsecNegotiationPolicyAction:** The **ipsecNegotiationPolicyAction** value description. The value MUST be one of the following.

Value	Meaning
{3F91A819-7647-11D1-864D-D46A00000000}	Block: The action to prevent the IP traffic from flowing needs to occur.
{8A171DD2-77E3-11d1-8659-A04F00000000}	Permit: The traffic is to be allowed to flow unhindered and unprotected by IPsec encapsulation.
{8A171DD3-77E3-11D1-8659-A04F00000000}	Secure: The traffic is to be protected by IPsec encapsulation (for example, authentication header (AH) and/or Encapsulating Security Payload (ESP) encapsulation).
{3F91A81A-7647-11D1-864D-D46A00000000}	Inbound pass-through: Allow traffic to be accepted if it is not IPsec-protected; however, initiate IKE to peer and evaluate the corresponding response against the traffic filters.

**IPsecData Attribute description:**

Note that all fields specified in the following tables MUST appear in little-endian byte order.

0	1	2	3	4	5	6	7	8	9	10	11	12	13	14	15	16	17	18	19	20	21	22	23	24	25	26	27	28	29	30	31
Negotiation-Policy-ID (16 bytes)																															
...																															
...																															
DataLength																															
Security-Offer-Count																															
Security-Offer-Data (variable)																															
...																															

**Negotiation-Policy-ID (16 bytes):** The identifier that specifies this BLOB as an NFA policy that describes the policy. MUST be the GUID whose string representation is "{80DC20B9-2EC8-11D1-A89E-00A0248D3021}".

**DataLength (4 bytes):** This is the length of the data that follows. This MUST be an unsigned integer. This field is always 1 byte less than the size of the following data encoded as an octet stream.

**Security-Offer-Count (4 bytes):** The number of security offers that are specified in the **Security-Offer-Data** that follows.

**Security-Offer-Data (variable):** The binary data that specifies additional policy data stored as specified in the following binary format. This binary data is in multiples of 80 bytes.

0	1	2	3	4	5	6	7	8	9	10	11	12	13	14	15	16	17	18	19	20	21	22	23	24	25	26	27	28	29	30	31
Lifetime-Seconds																															
Lifetime-KBytes																															
Negotiation-Options																															
PFS-QM-Required																															
Algorithm-Offer-Count																															
Algorithm-Offer-Data (60 bytes)																															
...																															
...																															

**Lifetime-Seconds (4 bytes):** The QM lifetime, as defined in [RFC2409], in seconds, that IKE is to negotiate. This MUST be an unsigned integer.

**Lifetime-KBytes (4 bytes):** The QM lifetime, in kilobytes, that IKE is to negotiate. This MUST be an unsigned integer.

**Negotiation-Options (4 bytes):** The policy specification modifiers to apply to the negotiation policy. This MUST be 0x00000000.

**PFS-QM-Required (4 bytes):** Whether or not IKE is to negotiate PFS when negotiating QM. This MUST be one of the following values.

Value	Meaning
0x00000000	QM-PFS is used.
0x00000001	QM-PFS is not used.

**Algorithm-Offer-Count (4 bytes):** The number of algorithm offers that are specified in the **Algorithm-Offer-Data** that follows; the maximum number supported is 3. This MUST be an unsigned integer.

**Algorithm-Offer-Data (60 bytes):** The binary data that specifies additional policy data are stored in three sets of the following binary format. For fields in this data, see [RFC2402] section 3.2 and [RFC2406] section 3.2. The size of this field is always 60 bytes, of which only the first **Algorithm-Offer-Count** \*20 bytes are significant, any other bytes in this field MUST be ignored.

0	1	2	3	4	5	6	7	8	9	0	1	2	3	4	5	6	7	8	9	0	1	2	3	4	5	6	7	8	9	0	1
Algorithm-Identifier																															
ESP-Integrity-Identifier																															
Offer-Type																															
Zero1																															
...																															

**Algorithm-Identifier (4 bytes):** The IPsec framing algorithm identifier; either AH or ESP.

If AH is used (as specified by Offer-Type), it MUST have one of the values specified in the following table.

Value	Meaning
AH[MD5] 0x00000001	AH framing with MD5.
AH[SHA-1] 0x00000002	AH framing with SHA-1.

If ESP is used (as specified by Offer-Type), it MUST have one of the values specified in the following table.

Value	Meaning
ESP[null] 0x00000001	ESP encapsulation with no encryption.
ESP[DES] 0x00000002	ESP encapsulation with Data Encryption Standard (DES) encryption.
ESP[3DES] 0x00000003	ESP encapsulation with Triple DES (3DES) encryption.

**ESP-Integrity-Identifier (4 bytes):** Specifies the Hash-based Message Authentication Code (HMAC) to use if ESP is specified by Offer-Type. This field MUST be one of the following values.

Value	Meaning
0x00000000	None (ESP is not used).
0x00000001	ESP integrity with MD5.
0x00000002	ESP integrity with SHA-1.

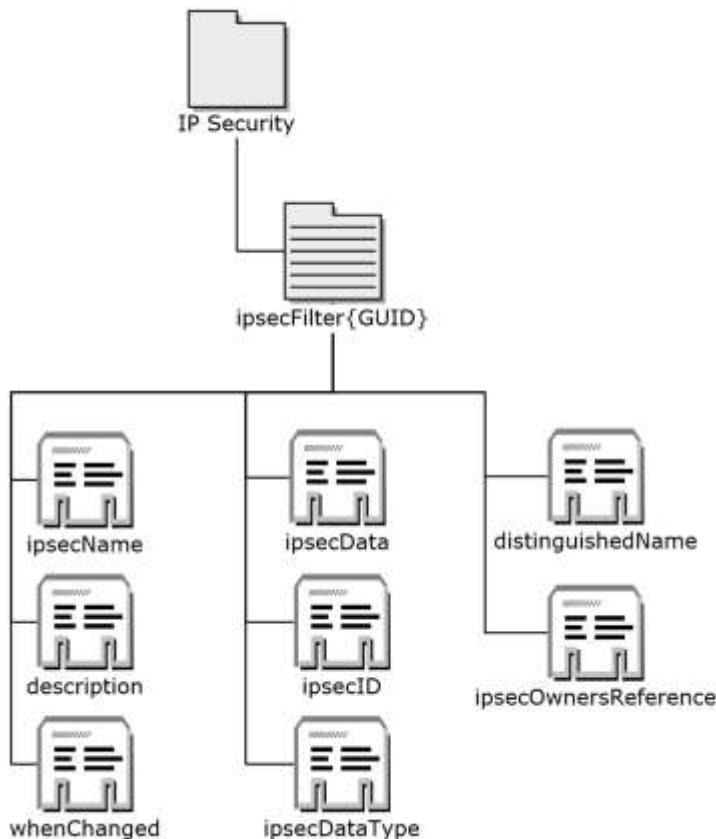
**Offer-Type (4 bytes):** The offer type that is presented; either Authentication or Encryption. This MUST be one of the following values.

Value	Meaning
0x00000001	AH encapsulation.
0x00000002	ESP encapsulation.

**Zero1 (8 bytes):** This value MAY be filled with 0x00 and MUST be ignored when read.

### 2.2.1.5 ipsecFilter Object Attribute Details

The Filter policy stores IP filter conditions. The **ipsecFilter** data attribute contains the IPsec filter policy information. This information includes what is commonly associated with IP filters (for example, source address/mask, destination address/mask, and port). The following diagram shows a Filter policy object.



**Figure 14: Filter policy object**

The ipsecFilter object creation MUST use the LDAP add functionality in conformance with [RFC2251] section 4.7.

The **ipsecFilter** object creation/modification MUST use the LDAP modify functionality in conformance with [RFC2251] section 4.6.

The **ipsecFilter** attributes are specified in the following subsection.

### 2.2.1.5.1 ipsecFilter{GUID} Object Description

The following table specifies the attributes of the **ipsecFilter class** object, as specified in [MS-ADSC], [MS-ADA1], and [MS-ADA3].

Name	Type	Description
<b>objectClass</b>	LDAPString	The Directory String that contains the object class. A typical value is "ipsecFilter". This attribute is only used during policy creation.
<b>ipsecName</b>	LDAPString	The user-constructed Directory String that contains the name for this filter. A typical value is "All traffic filter".
<b>description</b>	LDAPString	The user-constructed Directory String that is intended to contain a description of the filter group. A typical value is "My servers to protect".
<b>whenChanged</b>	UTC-coded string	The Unicode-generalized time syntax of the time and date that the policy was last changed. This value is set by the Active Directory server.
<b>ipsecID</b>	LDAPString	The Directory String that contains the curly braced GUID string value of the ipsecFilter object. A typical value is similar to the following: "{6A1E5C3F-72B7-11D2-ACF0-02603625CAFE}".
<b>distinguishedName</b>	Distinguished name	The Directory String description of the directory location of this ipsecFilter policy object. This MUST be in the DN format of [RFC2251]. This MUST be set by the protocol. A typical value is similar to the following: "CN=ipsecFilter{6A1E5C3F-72B7-11D2-ACF0-0260B025CAFE },CN=IP Security,CN=System,DC=myDomain,DC=contoso,DC=com".
<b>ipsecOwnersReference</b>	List of distinguished names	A list composed of Directory String references to the parent ipsecNFA objects that are associated with this filter. Note that a filter can be associated with multiple NFAs. The list MUST be composed of DN's in the format of [RFC2251]. The separator between two DN's is 2 bytes of '0'. For example: DN1 2bytesof0 DN2, where DN1 and DN2 are distinguished names.
<b>ipsecDataType</b>	LDAPString	The identifier that describes the format of the following <b>ipsecData</b> attribute. This MUST be the Directory String representation of the unsigned integer value 0x100.
<b>ipsecData</b>	Octet string	The octet string representation of the binary data that specifies additional policy data stored as described in the following <b>ipsecData</b> -specific table.

**Note** The ipsecFilter object as specified in LDAP messages ([MS-ADSC], section 2.71 "Class ipsecFilter") is encoded using BER, as defined in [RFC2251] section 5.1.

The following table specifies the **ipsecData** attribute-specific sections, corresponding names, and data types for the assigned values for the purpose of IPsec policy configuration.

The values of these settings MUST NOT be interpreted by this protocol; that is, they are to be applied as is to the IPsec component, which can interpret them independently of the protocol or mechanism that was used to configure them. A description of the interpretation by the IPsec component is provided for informative purposes (as opposed to the syntax, which is normative).

Note that all fields specified in the following tables MUST appear in little-endian byte order.

0	1	2	3	4	5	6	7	8	9	0	1	2	3	4	5	6	7	8	9	0	1	2	3	4	5	6	7	8	9	0	1
Filter-Policy-ID1 (16 bytes, optional)																															
...																															
...																															
Data-Length1																															
Number-Of-Filters1																															
Filter-Spec1 (variable)																															
...																															
Filter-Policy-ID2 (16 bytes, optional)																															
...																															
...																															
Data-Length2																															
Number-Of-Filters11 (optional)																															
Number-Of-Filters2 (optional)																															
Filter-Spec2 (variable)																															
...																															

**Filter-Policy-ID1 (16 bytes):** The identifier that specifies the BLOB as a collection of the legacy filter policy format. This is the GUID whose string representation is "{80DC20B5-2EC8-11D1-A89E-00A0248D3021}". This means that a legacy filter follows.

**Data-Length1 (4 bytes):** This field SHOULD<21> be the length of data, in bytes, of the **Filter-Spec1** field. This MUST be an unsigned integer.

**Number-Of-Filters1 (4 bytes):** The number of Filter-Spec1 (legacy filters) that are present.

**Filter-Spec1 (variable):** The format of the data for the Legacy (V1) filter. This structure is repeated **Number-Of-Filters1** times (or **Number-Of-Filters11** times when **Filter-Policy-ID2** is present).

0	1	2	3	4	5	6	7	8	9	0	1	2	3	4	5	6	7	8	9	0	1	2	3	4	5	6	7	8	9	0	1
Source-Length-Of-DNS-Name1																															
Source-DNS-Name1 (variable)																															

...		
Destination-Length-Of-DNS-Name1		
Destination-DNS-Name1 (variable)		
...		
Filter-Description-Length1		
Filter-Description1 (variable)		
...		
Filter-Specification-ID1 (16 bytes)		
...		
...		
Legacy-Mirror-Options		
Legacy-Source-Address		
Legacy-Source-Mask		
Legacy-Destination-Address		
Legacy-Destination-Mask		
Legacy-Tunnel-Address		
Legacy-Protocol		
Legacy-Source-Port	Legacy-Destination-Port	
Legacy-Is-Tunnel	Legacy-Special-Filter	Legacy-Filter-Options

**Source-Length-Of-DNS-Name1 (4 bytes):** The length of the **Source-DNS-Name1** field that follows.

**Source-DNS-Name1 (variable):** The source fully qualified domain name (FQDN) field whose length is described by **Source-Length-Of-DNS-Name1**.

**Destination-Length-Of-DNS-Name1 (4 bytes):** The length of the **Destination-DNS-Name1** field that follows.

**Destination-DNS-Name1 (variable):** The destination FQDN field whose length is described by **Destination-Length-Of-DNS-Name1**.

**Filter-Description-Length1 (4 bytes):** The length of the filter-description field that follows.

**Filter-Description1 (variable):** The user-constructed Unicode, NULL-terminated text string that is intended to contain a description of this individual filter (for example, *"Matches all ICMP packets between this computer and any other computer"*).

**Filter-Specification-ID1 (16 bytes):** The user-constructed identifier that identifies this individual legacy filter.

**Legacy-Mirror-Options (4 bytes):** An indicator that this filter needs to be mirrored. A mirrored filter is one that MUST be detected by generating a matching incoming and outgoing filter pair. (For example, "IP1 to IP2, mirrored" is detected as "IP1 to IP2" and "IP2 to IP1" directional filters.) This MUST be one of the following values.

Value	Meaning
0x00000000	This filter is not mirrored.
0x00000001	This filter is mirrored.

**Legacy-Source-Address (4 bytes):** The (IPv4) IP address of the traffic source address to apply the IPsec filter to. Note that 0x00000000 is a special value that means "any IP address".

**Legacy-Source-Mask (4 bytes):** The (IPv4) IP subnet mask for the source IP address specified in Source-Address.

**Legacy-Destination-Address (4 bytes):** The (IPv4) IP address of the traffic destination address to apply the IPsec filter to. Note that 0x00000000 is a special value that means "any IP address".

**Legacy-Destination-Mask (4 bytes):** The (IPv4) IP subnet mask for the source IP address specified in Destination-Address.

**Legacy-Tunnel-Address (4 bytes):** The optional (IPv4) IP address of the traffic IPsec tunnel mode endpoint to apply the IPsec filter to. Note that this field MUST NOT be interpreted unless the **Legacy-Is-Tunnel** field specifies that this is a tunnel filter.

**Legacy-Protocol (4 bytes):** The protocol number that specifies the (IPv4) IP traffic protocol to filter, for example, 0x00000006 for TCP and 0x00000011 for UDP. Note that 0x00000000 is a special value that means "any protocol". This MUST be an unsigned integer.

**Legacy-Source-Port (2 bytes):** The source port that this filter applies to. Note that 0x0000 is a special value that means "any port". This MUST be an unsigned integer.

**Legacy-Destination-Port (2 bytes):** The destination port that this filter applies to. Note that 0x0000 is a special value that means "any port". This MUST be an unsigned integer.

**Legacy-Is-Tunnel (1 byte):** Specifies that this filter is an IPsec tunnel-mode filter and the **Legacy-Tunnel-Address** field MUST be interpreted. This MUST be one of the following values.

Value	Meaning
0x00	This filter is not a tunnel filter.
0x01	This filter is a tunnel filter.

**Legacy-Special-Filter (1 byte):** Specifies that this filter is a special filter that has a predefined meaning and SHOULD<22> be interpreted based on the IP configuration of the host machine. One of the following values is used.



Value	Meaning
0x00	This is not a special filter.
0x01	This filter is to use the local system's DNS server(s) (IPv4) IP address for the source address.
0x02	This filter is to use the local system's WINS server(s) (IPv4) IP address for the source address.
0x03	This filter is to use the local system's DHCP server (IPv4) IP address for the source address.
0x04	This filter is to use the local system's default-gateway (IPv4) IP address for the source address.
0x81	This filter is to use the local system's DNS server(s) (IPv4) IP address for the destination address.
0x82	This filter is to use the local system's WINS server(s) (IPv4) IP address for the destination address.
0x83	This filter is to use the local system's DHCP server (IPv4) IP address for the destination address.
0x84	This filter is to use the local system's default-gateway (IPv4) IP address for the destination address.

**Legacy-Filter-Options (2 bytes):** The policy specification modifiers to apply to the filter policy. This MUST be 0x00.

**Filter-Policy-ID2 (16 bytes):** Optional. The identifier that specifies the BLOB as a collection of the new Filter policy format. This SHOULD<23> be the GUID whose string representation is "{35FECD3D-AE29-4373-8A6A-C5D8FAB2FB08}". This means that a newer filter format, Filter-Spec2, follows.

**Data-Length2 (4 bytes):** This field MUST be the length, in bytes, of the **Filter-Spec2** field. This MUST be an unsigned integer.

**Number-Of-Filters11 (4 bytes):** Optional. This field is present when **Filter-Policy-ID2** is specified. The number of **Filter-Spec1** (legacy filters) that are present. If this value is nonzero, it overrides the value present in **Number-Of-Filters1**.

**Number-Of-Filters2 (4 bytes):** Optional. This field is present when **Filter-Policy-ID2** is specified. The number of **Filter-Spec2** filters that are present.

**Filter-Spec2 (variable):** The format of the data for the version 2 (V2) filter.

0	1	2	3	4	5	6	7	8	9	10	11	12	13	14	15	16	17	18	19	20	21	22	23	24	25	26	27	28	29	30	31
Source-Length-Of-DNS-Name2																															
Source-DNS-Name2 (variable)																															
...																															
Destination-Length-Of-DNS-Name2																															
Destination-DNS-Name2 (variable)																															
...																															
Filter-Description-Length2																															

Filter-Description2 (variable)
...
Filter-Specification-ID2 (16 bytes)
...
...
Mirror-Flags
Source-Address-Data (40 bytes)
...
...
Destination-Address-Data (40 bytes)
...
...
Source-Port-Data
...
Destination-Port-Data
...
Filter-Protocol
Filter-Flags

**Source-Length-Of-DNS-Name2 (4 bytes):** The length of the **Source-DNS-Name2** field that follows.

**Source-DNS-Name2 (variable):** The source FQDN field whose length is described by **Source-Length-Of-DNS-Name2**.

**Destination-Length-Of-DNS-Name2 (4 bytes):** The length of **Destination-DNS-Name2** field that follows.

**Destination-DNS-Name2 (variable):** The destination FQDN field whose length is described by **Destination-Length-Of-DNS-Name2**.

**Filter-Description-Length2 (4 bytes):** The length of the filter-description field that follows.

**Filter-Description2 (variable):** The user-constructed Unicode, NULL-terminated text string that is intended to contain a description of this individual filter (for example, "Matches all ICMP packets between this computer and any other computer").

**Filter-Specification-ID2 (16 bytes):** The user-constructed identifier that identifies this individual filter.

**Mirror-Flags (4 bytes):** An indicator that this filter needs to be mirrored. A mirrored filter is one that MUST be realized by generating a matching incoming and outgoing filter pair. (For example, "IP1 to IP2, mirrored" is realized as "IP1 to IP2" and "IP2 to IP1" directional filters.) This MUST be one of the following values.

Value	Meaning
0x00000000	This filter is not mirrored.
0x00000001	This filter is mirrored.

**Source-Address-Data (40 bytes):** The IP address of the traffic source to apply the IPsec filter to. This is specified in the following binary format. Note that all addresses are expected in network byte order.<24>

0	1	2	3	4	5	6	7	8	9	10	11	12	13	14	15	16	17	18	19	20	21	22	23	24	25	26	27	28	29	30	31	32	33	34	35	36	37	38	39	40
IPsec-Address-Type																																								
IPsec-Address-Version																																								
IP-Address-Data-Format (32 bytes)																																								
...																																								
...																																								

**IPsec-Address-Type (4 bytes):** Specifies the type of address that the IPsec filter specifies. This includes special filter types that have a predefined meaning and are interpreted based on the IP configuration of the host machine. This MUST be one of the following values and MUST be an unsigned integer.

Value	Meaning
0x00000000	This is the filter that applies to all IP traffic (that is, any traffic filter).
0x00000001	This filter specifies a single IP address filter.
0x00000002	This filter specifies a range of IP addresses.
0x00000004	This filter specifies an IP subnet.
0x00000008	This filter is to use the local system's IP address(es) (that is, 'Me' traffic filter).
0x00000010	This filter is to use the local system's DNS server(s) IP address.
0x00000020	This filter is to use the local system's WINS server(s) IP address.
0x00000040	This filter is to use the local system's DHCP server IP address.

Value	Meaning
0x00000080	This filter is to use the local system's default-gateway IP address.

**IPsec-Address-Version (4 bytes):** Specifies the IP version (IPv4/IPv6) of an address that the IPsec filter specifies. This MUST be one of the following values and MUST be an unsigned integer.

Value	Meaning
0x00000001	This filter specifies an IP version 4 (IPv4) address.
0x00000002	This filter specifies an IP version 6 (IPv6) address.
0x00000003	This filter specifies both an IP version 4 (IPv4) address and an IP version 6 (IPv6) address.

The value 0x00000003 MUST only be used if the value of the **IPsec-Address-Type** is 0x00000008, 0x00000010, 0x00000020, 0x00000040, or 0x00000080.

**IP-Address-Data-Format (32 bytes):** The IP address or addresses of the traffic that defines the IPsec filter. This is specified in the following binary format. Note that all addresses are expected in network byte order.

0	1	2	3	4	5	6	7	8	9	10	11	12	13	14	15	16	17	18	19	20	21	22	23	24	25	26	27	28	29	30	31
IP-Address (16 bytes)																...															
...																IP-Address-Secondary (16 bytes)															
...																...															

**IP-Address (16 bytes):** The IP address of the traffic that defines the IPsec filter. If the **IPsec-Address-Version** field is 0x0001, this is the 4-byte (network byte order) representation of an IPv4 address (the remaining 12 bytes are not significant). If the **IPsec-Address-Version** field is 0x0002, this is the 16-byte (network byte order) representation of an IPv6 address. On reading, if the **IPsec-Address-Version** field is equal to 0x0003, the 16 bytes of the **IP-Address** field MUST be ignored. On writing, if the **IPsec-Address-Version** field is equal to 0x0003, the 16 bytes of the **IP-Address** field MUST be set to 0. Note that this field is only significant if the IPsec-Address-Type field is 0x0001, 0x0002, or 0x0004.

**IP-Address-Secondary (16 bytes):** The secondary IP address of the traffic that defines the IPsec filter. If the **IPsec-Address-Version** field is 0x0001, this is the 4-byte (network byte order) representation of an IPv4 address (the remaining 12 bytes are not significant). If the **IPsec-Address-Version** field is 0x0002, this is the 16-byte (network byte order) representation of an IPv6 address. Note that this field is only significant if the **IPsec-Address-Type** field is 0x0002 or 0x0004. If the **IPsec-Address-Type** field is 0x0002, this defines the last address in the applicable range of IP addresses for this filter. If the **IPsec-Address-Type** field is 0x0004, this defines the subnet mask for this filter. When a subnet filter is defined: if the **IPsec-Address-Version** field is 0x0001, this is the 4-byte (network

byte order) representation of the IPv4 subnet mask; if the **IPsec-Address-Version** field is 0x0002, this is the 1-byte representation of the IPv6 subnet mask. The IPv6 subnet mask is a byte number that counts the number of bits prefixes that compose the mask.

**Destination-Address-Data (40 bytes):** The IP address of the traffic destination to apply the IPsec filter to. This SHOULD<25> be specified in the same binary format as shown previously in the **Source-Address-Data** field and in the following table.

0	1	2	3	4	5	6	7	8	9	10	11	12	13	14	15	16	17	18	19	20	21	22	23	24	25	26	27	28	29	30	31
<b>IPsec-Address-Type</b>																															
<b>IPsec-Address-Version</b>																															
<b>IP-Address-Data-Format (32 bytes)</b>																															
...																															
...																															

**IPsec-Address-Type (4 bytes):** Specifies the type of address that the IPsec filter specifies. This includes special filter types that have a predefined meaning and are interpreted based on the IP configuration of the host machine. This MUST be one of the following values and MUST be an unsigned integer.

Value	Meaning
0x00000000	This is the filter that applies to all IP traffic (that is, 'Any' traffic filter).
0x00000001	This filter specifies a single IP address filter.
0x00000002	This filter specifies a range of IP addresses.
0x00000004	This filter specifies an IP subnet.
0x00000008	This filter is to use the local system's IP address(es) (that is, 'Me' traffic filter).
0x00000010	This filter is to use the local system's DNS server(s) IP address.
0x00000020	This filter is to use the local system's WINS server(s) IP address.
0x00000040	This filter is to use the local system's DHCP server IP address.
0x00000080	This filter is to use the local system's default-gateway IP address.

**IPsec-Address-Version (4 bytes):** Specifies the IP version (IPv4/IPv6) of an address that the IPsec filter specifies. This MUST be one of the following values, and this MUST be an unsigned integer.

Value	Meaning
0x00000001	This filter specifies an IP version 4 (IPv4) address.
0x00000002	This filter specifies an IP version 6 (IPv6) address.
0x00000003	This filter specifies both an IP version 4 (IPv4) address and an IP version 6 (IPv6) address.

The value 0x00000003 MUST only be used if the value of the **IPsec-Address-Type** is 0x00000008, 0x00000010, 0x00000020, 0x00000040, or 0x00000080.

**IP-Address-Data-Format (32 bytes):** The IP address(es) of the traffic that define(s) the IPsec filter. This is specified in the following binary format. Note that all addresses are expected in network byte order.

0	1	2	3	4	5	6	7	8	9	10	11	12	13	14	15	16	17	18	19	20	21	22	23	24	25	26	27	28	29	30	31
IP-Address (16 bytes)																...															
...																IP-Address-Secondary (16 bytes)															
...																...															

**IP-Address (16 bytes):** The IP address of the traffic that defines the IPsec filter. If the **IPsec-Address-Version** field is 0x0001, this is the 4-byte (network byte order) representation of an IPv4 address (the remaining 12 bytes are not significant). If the **IPsec-Address-Version** field is 0x0002, this is the 16-byte (network byte order) representation of an IPv6 address. On reading, if the **IPsec-Address-Version** field is equal to 0x0003, the 16 bytes of the **IP-Address** field MUST be ignored. On writing, if the **IPsec-Address-Version** field is equal to 0x0003, the 16 bytes of the **IP-Address** field MUST be set to 0. Note that this field is only significant if the **IPsec-Address-Type** field is 0x0001, 0x0002, or 0x0004.

**IP-Address-Secondary (16 bytes):** The secondary IP address of the traffic that defines the IPsec filter. If the **IPsec-Address-Version** field is 0x0001, this is the 4-byte (network byte order) representation of an IPv4 address (the remaining 12 bytes are not significant). If the **IPsec-Address-Version** field is 0x0002, this is the 16-byte (network byte order) representation of an IPv6 address. Note that this field is only significant if the **IPsec-Address-Type** field is 0x0002, or 0x0004. If the **IPsec-Address-Type** field is 0x0002, this defines the last address in the applicable range of IP addresses for this filter. If the **IPsec-Address-Type** field is 0x0004, this defines the subnet mask for this filter. When a subnet filter is defined: if the **IPsec-Address-Version** field is 0x0001, this is the 4-byte (network byte order) representation of the IPv4 subnet mask; if the **IPsec-Address-Version** field is 0x0002, this is the 1-byte representation of the IPv6 subnet mask. The IPv6 subnet mask is a byte number that counts the number of bits prefixes that compose the mask.

**Source-Port-Data (8 bytes):** The source port that this filter applies to. This is specified in the following binary format.<26>

0	1	2	3	4	5	6	7	8	9	10	11	12	13	14	15	16	17	18	19	20	21	22	23	24	25	26	27	28	29	30	31
IPsec-Source-Port-Type																IPsec-Source-Port															
																IPsec-Source-Port-Range-End															

**IPsec-Source-Port-Type (4 bytes):** Specifies the type of port that the IPsec filter specifies. This includes special port types that have a predefined meaning. This MUST be one of the following values and MUST be an unsigned integer.

Value	Meaning
0x00000000	This is the filter that applies to all ports (that is, 'Any' traffic filter).
0x00000001	This filter specifies a single port.
0x00000002	This filter specifies a range of ports.

**IPsec-Source-Port (2 bytes):** Specifies the port number for the IPsec filter. This includes the following special modifiers: if IPsec-Port-Type is 0x0000, this value is not significant; if IPsec-Port-Type is 0x0001, this is the port the IPsec filter applies to; if IPsec-Port-Type is 0x0002, this is the first port in the port range to apply the IPsec filter to.

**IPsec-Source-Port-Range-End (2 bytes):** Specifies the port number for the end of the port range for the IPsec filter. This includes the following special modifiers: if IPsec-Port-Type is 0x0000 or IPsec-Port-Type is 0x0001, this value is not significant; if IPsec-Port-Type is 0x0002, this is the last port in the port range to apply the IPsec filter to.

**Destination-Port-Data (8 bytes):** The destination port that this filter applies to. This is specified in the same binary format as shown previously in the **Source-Port-Data** field and in the following table.<27>

0	1	2	3	4	5	6	7	8	9	10	11	12	13	14	15	16	17	18	19	20	21	22	23	24	25	26	27	28	29	30	31
IPsec-Destination-Port-Type																															
IPsec-Destination-Port																IPsec-Destination-Port-Range-End															

**IPsec-Destination-Port-Type (4 bytes):** Specifies the type of port that the IPsec filter specifies. This includes special port types that have a predefined meaning. This MUST be one of the following values and MUST be an unsigned integer.

Value	Meaning
0x00000000	This is the filter that applies to all ports (that is, 'Any' traffic filter).
0x00000001	This filter specifies a single port.
0x00000002	This filter specifies a range of ports.

**IPsec-Destination-Port (2 bytes):** Specifies the port number for the IPsec filter. This includes the following special modifiers: if IPsec-Port-Type is 0x0000, this value is not significant; if IPsec-Port-Type is 0x0001, this is the port the IPsec filter applies to; if IPsec-Port-Type is 0x0002, this is the first port in the port range to apply the IPsec filter to.

**IPsec-Destination-Port-Range-End (2 bytes):** Specifies the port number for the end of the port range for the IPsec filter. This includes the following special modifiers: if IPsec-Port-Type is 0x0000 or IPsec-Port-Type is 0x0001, this value is not significant; if IPsec-Port-Type is 0x0002, this is the last port in the port range to apply the IPsec filter to.

**Filter-Protocol (4 bytes):** This SHOULD<28> be an unsigned integer. The protocol number that specifies the IP traffic protocol to filter. For example, 0x00000006 for TCP and 0x00000011 for UDP. Note that 0x00000000 is a "special" value that means "Any Protocol".

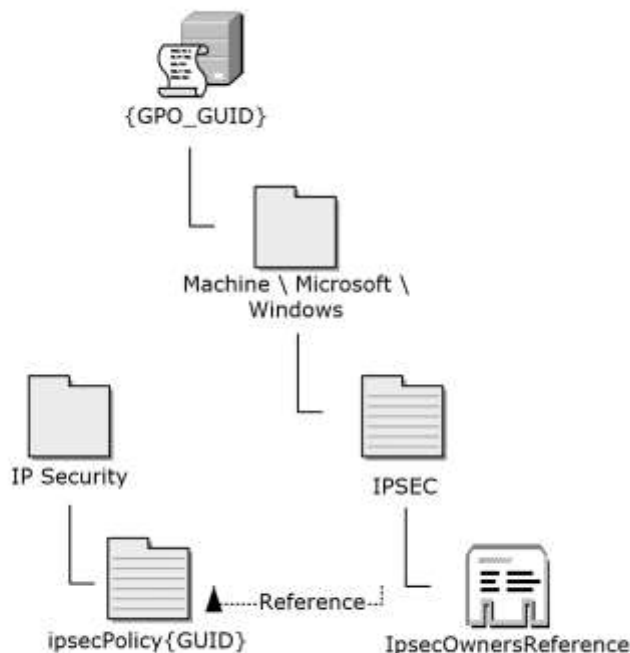
**Filter-Flags (4 bytes):** The flags that specify optional additional behavior. This SHOULD<29> be a word value and be one of the following values.

Value	Meaning
0x00000000	No flag value. This MUST NOT be interpreted as significant.
0x00000008	Use version-2 (v2) filter ranges. This value is set when using address ranges. If the address set is expressed as both the version-1 (v1) expanded subnets and the v2 address range, the meaning of the flag is to ignore the v1 expanded subnets because it can process the v2 filter expressed as an address range.

## 2.2.2 IPsec Policy Assignment

This section specifies how an IPsec Group Policy administrative plug-in assigns an active IPsec policy to a GPO.

The active IPsec policy MUST be assigned to a GPO by writing to the `ipsecOwnersReference` attribute, as specified in [MS-ADA1] section 2.330, "Attribute `ipsecOwnersReference`", of the assigned GPO "`Machine\Microsoft\Windows\IPSEC`" data object. The `ipsecOwnersReference` value MUST be a reference to the Active Directory location of the assigned IPsec policy that MUST be stored in the `System\IP Security` container as shown in the following diagram.



**Figure 15: Location of the `ipsecOwnersReference` value\System\IP Security container**

Two additional values MUST be written to the IPsec object to name and describe the assigned policy; they are the `ipsecName` and `Description` values as specified in [MS-ADA1].

The following table specifies the expected contents of the IPSEC object as specified by [MS-ADA1].



Name	Type	Description
ipsecOwnersReference	Distinguished name	The Directory String that represents the LDAP reference to the location (in Active Directory) of the policy that is currently assigned to the GPO. This MUST be in the distinguished name (DN) format of [RFC2251].
ipsecName	LDAPString	An optional user-defined Directory String that names the currently assigned policy. This is intended for display purposes only.
description	LDAPString	An optional user-defined Directory String that describes the currently-assigned policy. This is intended for display purposes only.

To assign an active IPsec policy, the LDAP portion of the message is an LDAP addRequest as specified in [RFC2251] section 4.7.

The following table specifies the values for Entry and attributes parameters, as applicable to LDAP addRequest messages.

Parameter	Value
Entry	The IPSEC object distinguished name for the GPO: cn=ipsec,cn=Windows,cn=Microsoft,cn=Machine,cn={GPO GUID},cn=policies,cn=system,<domain naming context>.
attributes	This field MUST specify the Active Directory object class: objectClass=ipsecPolicy.

If the **resultCode** field of the "AddResponse" message ([RFC2251] section 4.7) is nonzero, the add operation failed and this protocol sequence MUST log an error.

To modify an already assigned IPsec policy, the LDAP portion of the message is an LDAP modifyRequest (that MUST specify the replace operation) as specified in [RFC2251] section 4.6.

The following table specifies the values for Entry and attributes parameters, as applicable to LDAP modifyRequest messages.

Parameter	Value
Entry	The IPSEC object distinguished name (DN) for the GPO: cn=ipsec,cn=Windows,cn=Microsoft,cn=Machine,cn={GPO GUID},cn=policies,cn=system,<domain naming context>.
attributes	This field MUST specify the <b>ipsecOwnersReference</b> attribute. The <b>ipsecOwnersReference</b> value MUST be CN=ipsecPolicy{GUID},CN=IP Security,CN=System,<domain naming context>. It MUST also specify any additional/optional attributes that are set on the object, such as the <b>ipsecName</b> and <b>description</b> attributes. If an optional attribute is not set on the object, that attribute MUST NOT be included in the LDAP modifyRequest message.

If the **resultCode** field of the "ModifyResponse" message ([RFC2251] section 4.6) is nonzero, the modify operation failed and this protocol sequence MUST log an error.

### 2.2.3 IPsec Policy Retrieval

This section specifies LDAP SearchRequest message parameters for the retrieval of policy location, name, and description; the retrieval of policy data; and for determining whether an IPsec policy exists.

### 2.2.3.1 Policy Location, Name, and Description Retrieval

When retrieving the assigned policy location, name, and description, an LDAP SearchRequest message MUST be sent to the domain controller with the parameters that follow:

Parameter	Value
baseObject	The IPsec policy DN that corresponds to the GPO in which to search for IPsec protocol settings: cn=ipsec,cn=Windows,cn=Microsoft,cn=Machine,cn={GPO GUID},cn=policies,cn=system,<domain naming context>
Scope	This value MUST be equal to 0, for the baseObject scope (as defined in [RFC2251]).
derefAliases	This MUST be set to 0 (neverDerefAliases) to dereference in searching.
sizeLimit	No limit is set (this MUST be set to 0).
timeLimit	The time limit MUST be infinite (it MUST be set to 0).
typesOnly	This MUST be set to FALSE as defined in [RFC2251].
Filter	The following LDAP filter (as specified in [RFC2254]) MUST be used: (objectclass=*)
Attributes	None

If the preceding LDAP SearchRequest succeeds, then the following LDAP SearchRequest message MUST be sent to the domain controller with the parameters that follow:

Parameter	Value
baseObject	The IPsec policy DN that corresponds to the GPO in which to search for IPsec protocol settings: cn=ipsec,cn=Windows,cn=Microsoft,cn=Machine,cn={GPO GUID},cn=policies,cn=system,<domain naming context>
Scope	This value MUST be the value 0, for the baseObject scope (as defined in [RFC2251]).
derefAliases	This MUST be set to 0 (neverDerefAliases) to dereference in searching.
sizeLimit	No limit is set (this MUST be set to 0).
timeLimit	The time limit MUST be infinite (it MUST be set to 0).
typesOnly	This MUST be set to FALSE as defined in [RFC2251].
Filter	The following LDAP filter (as specified in [RFC2254]) MUST be used: (objectclass=*)
Attributes	This field MUST specify the attributes ipsecOwnersReference, description, and ipsecName, as specified in section 2.2.2.

### 2.2.3.2 Policy Data Retrieval

To retrieve the assigned policy data, an LDAP SearchRequest MUST be sent to the domain controller with following parameters:

Parameter	Value
baseObject	The IPsec policy store DN for the Internet Protocol security container: cn=ip security,cn=system,<domain naming context>
Scope	This MUST be the value 1, for the singleLevel scope as defined in [RFC2251].
derefAliases	This MUST be set to 0 (neverDerefAliases) to dereference in searching.
sizeLimit	No limit is set (this MUST be set to 0).
timeLimit	The time limit MUST be infinite (it MUST be set to 0).
typesOnly	This MUST be set to FALSE as defined in [RFC2251].
Filter	The following LDAP filter ([RFC2254]) MUST be used: (&(objectclass=POLICY_OBJECT_TYPE)(cn=OBJECT_NAME)) where POLICY_OBJECT_TYPE is "ipsecPolicy", "ipsecISAKMPPolicy", "ipsecNFA", "ipsecFilter", or "ipsecNegotiationPolicy" as appropriate; and OBJECT_NAME is the object name with the string representation of the identifying GUID appended, for example: (&(objectclass=ipsecPolicy)(cn=ipsecPolicy{6A1E4C3F-72C7-1232-ACF0-0260B025CAFE})). In this example, (cn=ipsecPolicy{6A1E4C3F-72C7-1232-ACF0-0260B025CAFE}) is extracted from the <b>ipsecOwnersReference</b> obtained in section 2.2.3.1.
Attributes	This field MUST specify the attributes that are specific to the individual policy object, as specified in sections 2.2.1.1, 2.2.1.2, 2.2.1.3, 2.2.1.4, and 2.2.1.5.

## 2.3 Directory Service Schema Elements

The Group Policy: Core Protocol accesses the Directory Service schema classes and attributes listed in the following table. For the syntactic specifications of the following <Class> or <Class> <Attribute> pairs, refer to: [MS-ADSC], [MS-ADA1], [MS-ADA2], and [MS-ADA3].

Class	Attribute
ipsecPolicy	objectClass ipsecName description whenChanged ipsecID distinguishedName ipsecISAKMPReference ipsecNFAResource ipsecDataType ipsecData
ipsecFilter	objectClass ipsecName description whenChanged ipsecID distinguishedName ipsecOwnersReference ipsecDataType

<b>Class</b>	<b>Attribute</b>
	ipsecData
ipsecNegotiationPolicy	objectClass ipsecName Description whenChanged ipsecID distinguishedName ipsecNegotiationPolicyAction ipsecNegotiationPolicyType ipsecOwnersReference ipsecDataType ipsecData
ipsecNFA	objectClass ipsecName description whenChanged ipsecID distinguishedName ipsecFilterReference ipsecNegotiationPolicyReference ipsecOwnersReference ipsecDataType ipsecData
ipsecISAKMPPolicy	objectClass ipsecName whenChanged ipsecID distinguishedName ipsecOwnersReference ipsecDataType ipsecData

## 3 Protocol Details

### 3.1 IPsec Group Policy Administrative Plug-in Details

The IPsec administrative plug-in consists of a user interface that allows an IPsec administrator to author an IPsec policy and assign it to a GPO. First, the values that are entered by the administrator are used to form IPsec creation/modification messages as specified in IPsec Policy Creation/Modification (section 2.2.1) and IPsec policy assignment messages, as specified in IPsec Policy Assignment (section 2.2.2). These messages are then sent to Active Directory and stored as the IPsec policy, as explained in IPsec Extension Overview (section 1.3.2).

#### 3.1.1 Abstract Data Model

This section specifies a conceptual model of possible data organization that an implementation can maintain to participate in this protocol. The described organization is provided to facilitate the explanation of how the protocol behaves. This document does not mandate that implementations adhere to this model as long as their external behavior is consistent with that described in this document.

For state, the plug-in simply maintains the list of <name of setting, value of setting> pairs for the settings specified in section 2.2, "Message Syntax", that are suitable for displaying in the user interface.

**ADConnectionHandle:** An **ADConnection** structure (see "ADConnection Abstract Data Model", in [MS-ADTS] section 7.3) of type **ADCONNECTION\_HANDLE** (see [MS-DTYP] section 2.2.2, "ADCONNECTION\_HANDLE") that tracks a connection to an Active Directory server.

Note that an **ADCONNECTION\_HANDLE** object is returned by the **ADConnection** initialization operation, as defined in section 3.2.5.2.

#### 3.1.2 Timers

None.

#### 3.1.3 Initialization

When the IPsec administrative plug-in starts, the Group Policy Protocol component (as specified in [MS-GPOL] (section 1.3.3.1), "Server Discovery and Group Policy Object Association" and [MS-GPOL] (section 1.3.3.2), "GPO Retrieval") gives it an LDAP path (as defined in [RFC2251]) that identifies the GPO path that contains the IPsec policy. The plug-in **MUST** then use this path to read the current active policy (if any) from the GPO path by using the messages specified in section 3.2.5.3.

The IPsec administrative plug-in **MUST** then retrieve the details of the IPsec policy objects that are currently available for assignment to the GPO from the IP Security Active Directory container, as specified in section 3.2.5.4. If this fails, administrators **MUST** be informed so that they can determine the appropriate action to take.

#### 3.1.4 Higher-Layer Triggered Events

The higher-layer triggered events are: policy creation, policy modification, policy deletion, reading the policy, and assigning the policy to a GPO.

The administrator triggers each of these events by using the administrative plug-in.

On the policy creation/modify, the IPsec Protocol plug-in MUST generate the messages to create or modify the IPsec policy in the Active Directory store, as specified in IPsec Policy Creation/Modification (section 2.2.1).

On policy reading, the IPsec Protocol plug-in MUST generate the messages specified in section 3.1.5.4.

On policy deleting, the IPsec Protocol plug in MUST generate the messages specified in section 3.1.5.7.

For assigning policy to a GPO, the IPsec Protocol plug-in MUST generated the messages as specified in section 3.1.5.8.

In all cases, if this fails, the administrator MUST be informed so that they can determine the appropriate action to take.

### **3.1.5 Message Processing Events and Sequencing Rules**

#### **3.1.5.1 Configuring an LDAP BindRequest**

The following protocol sequences MUST be generated by the administrative plug-in.

##### **To configure an LDAP BindRequest:**

1. Binding MUST be handled by passing abstract element ADConnectionHandle to [MS-ADTS] section 7.6.1.4.
2. If the TaskReturnStatus does not indicate success (0), then the administrative plug-in MUST log an error and MUST terminate policy reading.

#### **3.1.5.2 Terminating the LDAP BindRequest**

To close the connection opened by a previous LDAP BindRequest, the administrative plug-in MUST unbind as specified in [MS-ADTS] section 7.6.1.5. The administrative plug-in MUST pass its ADConnectionHandle as a parameter to the unbind task.

#### **3.1.5.3 Retrieving the Assigned Policy Location, Name, and Description**

The administrative plug-in MUST connect to the domain controller as specified in sections 3.2.5.1 and 3.2.5.2. The administrative plug-in MUST retrieve the assigned policy location, name, and description, as specified in section 3.2.5.3. Thereafter, terminate the BindRequest, as defined in section 3.1.5.2.

#### **3.1.5.4 Reading the Assigned Policy Data**

The administrative plug-in MUST connect to the domain controller as specified in section 3.2.5.1 and 3.2.5.2. The administrative plug-in MUST read the existing group policy, using the appropriate parameters and values, as specified in sections 3.2.5.3 and 3.2.5.4. Thereafter, terminate the LDAP BindRequest, as specified in section 3.1.5.2.

#### **3.1.5.5 Writing the Assigned Policy Data**

The administrative plug-in MUST connect to the domain controller as specified in sections 3.2.5.1 and 3.2.5.2. To write the new IPsec policy, the administrative plug-in MUST perform the LDAP operation specified in [MS-ADTS] section 7.6.1.6, "Performing an LDAP Operation on an ADConnection". The TaskInputADConnection value MUST be the ADCONNECTION\_HANDLE object ([MS-DTYP] section 2.2.2, "ADCONNECTION\_HANDLE") stored in **ADConnectionHandle**. The TaskInputRequestMessage MUST contain an LDAP AddRequest message ([RFC2251] section 4.7) with the following parameters:

Parameter	Value
Entry	The value for this parameter MUST be CN=ObjectPath, CN=IP Security, CN=System, DN for the root of the domain; where objectpath is ipsecfilter{Guid} (section 2.2.1.5), ipsecISAKMPPolicy{Guid} (section 2.2.1.2), ipsecNegotiationPolicy{Guid} (section 2.2.1.4), IPsecNFA{Guid} (section 2.2.1.3), or IpsecPolicy{Guid} (section 2.2.1.1).
Attributes	<p>This field MUST specify the following attributes (sections 2.2.1.1, 2.2.1.2, 2.2.1.3, 2.2.1.4, and 2.2.1.5):</p> <p>For all objects ipsecfilter{Guid}, ipsecISAKMPPolicy{Guid}, ipsecNegotiationPolicy{Guid}, IPsecNFA{Guid}, IpsecPolicy{Guid}:</p> <ul style="list-style-type: none"> <li>▪ <b>objectClass</b></li> <li>▪ <b>ipsecName</b></li> <li>▪ <b>ipsecID</b></li> <li>▪ <b>distinguishedName</b></li> <li>▪ <b>description</b></li> <li>▪ <b>ipsecData</b></li> <li>▪ <b>ipsecDataType</b></li> </ul> <p>For ipsecISAKMPPolicy{Guid}:</p> <ul style="list-style-type: none"> <li>▪ <b>ipsecOwnersReference</b></li> </ul> <p>For ipsecfilter{Guid}:</p> <ul style="list-style-type: none"> <li>▪ <b>ipsecOwnersReference</b></li> </ul> <p>For ipsecNegotiationPolicy{Guid}:</p> <ul style="list-style-type: none"> <li>▪ <b>ipsecOwnersReference</b></li> <li>▪ <b>ipsecNegotiationPolicyAction</b></li> <li>▪ <b>ipsecNegotiationPolicyType</b></li> </ul> <p>For IPsecNFA{Guid}:</p> <ul style="list-style-type: none"> <li>▪ <b>ipsecOwnersReference</b></li> </ul>

The administrative plug-in waits for a response. If the TaskReturnStatus does not signal success (0), then the administrative plug-in MUST log an error, and then unbind as specified in section 3.1.5.2.

**Note** When writing the new IPsec policy is complete, terminate the BindRequest as specified in section 3.1.5.2.

### 3.1.5.6 Modifying the Assigned Policy Data

The administrative plug-in MUST connect to the domain controller as specified in sections 3.2.5.1 and 3.2.5.2. To modify the policy, the administrative-side plug-in modifies the existing policy object in Active Directory.

To accomplish this, an LDAP operation MUST be performed, as specified in [MS-ADTS] section 7.6.1.6, "Performing an LDAP Operation on an ADConnection". The TaskInputADConnection value MUST be the ADCONNECTION\_HANDLE object ([MS-DTYP], section 2.2.2, "ADCONNECTION\_HANDLE") stored in **ADConnectionHandle**. The TaskInputRequestMessage MUST contain an LDAP ModifyRequest message ([RFC2251] section 4.6) with the following parameters:

Parameter	Value
Entry	The value for this parameter MUST be CN=ObjectPath, CN=IP Security, CN=System, DN for the root of the domain; where ObjectPath is ipsecfilter{Guid} (section 2.2.1.5), ipsecISAKMPPolicy{Guid} (section 2.2.1.2), ipsecNegotiationPolicy{Guid} (section 2.2.1.4) IPsecNFA{Guid} (section 2.2.1.3), or IpsecPolicy{Guid} (section 2.2.1.1).
Attributes	<p>This field MUST specify any or all of the following attributes (sections 2.2.1.1, 2.2.1.2, 2.2.1.3, 2.2.1.4, and 2.2.1.5):</p> <p>For all objects:</p> <ul style="list-style-type: none"><li>▪ <b>ipsecData</b></li><li>▪ <b>ipsecDataType</b></li></ul> <p>For IpsecPolicy{Guid} objects:</p> <ul style="list-style-type: none"><li>▪ <b>ipsecISAKMPReference</b></li><li>▪ <b>ipsecNFAResource</b></li></ul> <p>For IPsecNFA{Guid} objects:</p> <ul style="list-style-type: none"><li>▪ <b>ipsecFilterReference</b></li><li>▪ <b>ipsecNegotiationPolicyReference</b></li></ul> <p>For ipsecFilter{Guid}, ipsecNegotiationPolicy{Guid}, and ipsecISAKMPPolicy{Guid} objects:</p> <ul style="list-style-type: none"><li>▪ <b>ipsecOwnersReference</b></li></ul>

The administrative plug-in waits for a response. If the TaskReturnStatus does not signal success (0), then the administrative plug-in MUST log an error, and then unbind as specified in section 3.1.5.2.

**Note** To terminate the LDAP BindRequest and close the connection, the administrative plug-in MUST make an LDAP UnBindRequest corresponding to the LDAP BindRequest, as indicated in section 3.1.5.2.

### 3.1.5.7 Deleting the Assigned Policy Data

To delete an existing object, the administrative plug-in MUST connect to the domain controller as specified in sections 3.2.5.1 and 3.2.5.2. The administrative-side plug-in MUST delete the existing object in the Active Directory that contains the particular IPsec settings. To accomplish this, an LDAP operation MUST be performed, as specified in [MS-ADTS], section 7.6.1.6, "Performing an LDAP Operation on an ADConnection". The TaskInputADConnection value MUST be the



ADCONNECTION\_HANDLE object ([MS-DTYP], section 2.2.2, "ADCONNECTION\_HANDLE") stored in **ADConnectionHandle**. The TaskInputRequestMessage MUST contain an LDAP delRequest message ([RFC2251] section 4.8) with the following parameters:

Parameter	Value
Entry	The value for this parameter MUST be CN=ObjectPath, CN=IP Security, CN=System, DN for the root of the domain; where ObjectPath is ipsecfilter{Guid} (section 2.2.1.5), ipsecISAKMPPolicy{Guid} (section 2.2.1.2), ipsecNegotiationPolicy{Guid} (section 2.2.1.4), IPsecNFA{Guid} (section 2.2.1.3), or IpsecPolicy{Guid} (section 2.2.1.1).

The administrative plug-in waits for a response. If the TaskReturnStatus does not signal success (0), the administrative plug-in MUST log an error, and then unbind as specified in section 3.1.5.2.

**Note** This message deletes the existing Active Directory object for the corresponding policy. To terminate the LDAP BindRequest and close the connection, the administrative plug-in MUST make an LDAP UnBindRequest corresponding to the initial LDAP BindRequest (section 3.1.5.2).

When deleting an object, the administrative plug-in MUST fail the delete (and report an error back to the user) if there are outstanding references to the object being deleted in the following cases:

- On attempting to delete an ipsecFilter, if any IPsecNFA object references that filter object, the delete MUST fail. Deleting an ipsecFilter MUST NOT modify any existing IPsecNFA objects.
- On attempting to delete an ipsecNegotiationPolicy object, if any IPsecNFA object references that policy object, the delete MUST fail. Deleting an ipsecNegotiationPolicy object MUST NOT modify any existing IPsecNFA objects.
- On attempting to delete an ipsecISAKMPPolicy object, if any ipsecPolicy object references that ipsecISAKMPPolicy object, the delete MUST fail. Deleting an ipsecISAKMPPolicy object MUST NOT modify any existing ipsecPolicy objects.

On deleting an IPsecNFA object, the order of operations MUST be as follows:

1. The ipsecNFAReference value MUST be updated to remove the reference to the deleted NFA from any ipsecPolicy objects that reference the deleted IPsecNFA object. On failure, the delete operation MUST be terminated and an error logged.
2. The IPsecNFA reference in the ipsecOwnersReference of the ipsecNegotiationPolicy object MUST be deleted. On failure, the delete operation MUST be terminated and an error logged.
3. The IPsecNFA reference in the ipsecOwnersReference of the ipsecFilter(s) object MUST be deleted. On failure, the delete operation MUST be terminated and an error logged.
4. The IPsecNFA object MUST be deleted. On failure, the delete operation MUST be terminated and an error logged.

On deleting an ipsecPolicy object, the order of operations is as follows:

1. All IPsecNFA objects associated with the ipsecPolicy object MUST first be deleted. On failure, the delete operation MUST be terminated and an error logged.
2. The **ipsecOwnersReference** field of the ipsecISAKMPPolicy object that is referenced by the deleted ipsecPolicy object MUST be updated to remove the reference to the deleted ipsecPolicy object. On failure, the error MUST be ignored and the delete operation continued.
3. The ipsecPolicy object MUST be deleted. On failure, an error MUST be logged.
4. If the newly deleted ipsecPolicy object is currently assigned (as specified in section 3.1.5.8), the assigned policy location **ipsecOwnersReference**, **description**, and **ipsecName** MAY<30> be updated to remove the reference to the newly deleted policy object.

All reference modification MUST be done as specified in section 3.1.5.6. Object deletion MUST be done as specified in this section.

### 3.1.5.8 Policy Assignment

The **Policy Assignment** event is invoked to assign an ipsecPolicy object to a GPO.

The parameters to the **Policy Assignment** event are as follows.

Parameter	Description
GPO Path	A string containing the distinguished name (DN) of the GPO to which the ipsecPolicy object is being assigned
ipsecOwnersReference	A string containing the DN of the ipsecPolicy object being assigned
ipsecName	A string containing the name of the policy being assigned
description	A string containing a description of the policy being assigned

To assign the policy to the GPO, the administrative plug-in MUST perform the following operations in order:

1. The administrative plug-in MUST locate a Domain Controller as specified in section 3.2.5.1. If this operation fails, the administrative plug-in MUST stop processing the policy assignment event.
2. The administrative plug-in MUST establish a connection to the Domain Controller as specified in section 3.2.5.2. If this operation fails, the administrative plug-in MUST stop processing the policy assignment event.
3. The administrative plug-in MUST attempt to retrieve the assigned policy location as specified in section 3.2.5.3. The DN for the IPSEC object MUST be specified as "CN=IPSEC, CN=Windows, CN=Microsoft, <GPO path>". Note that this operation is performed only to determine if the IPSEC object already exists; the returned attributes (if any) are ignored.
4. If any of the SearchRequests performed in step 3 returns a TaskReturnStatus ([MS-ADTS] section 7.6.1.6, Performing an LDAP Operation on an ADConnection) other than success (0) or "No such object" (32), the administrative plug-in MUST terminate the BindRequest as specified in section 3.1.5.2 and MUST stop processing the policy assignment event.
5. If all of the SearchRequests performed in step 3 return a TaskReturnStatus of success (0), the administrative plug-in MUST skip to step 7; that is, it MUST NOT send an addRequest.
6. Otherwise, the administrative plug-in MUST send an LDAP addRequest as specified in section 2.2.2. If the addRequest returns a TaskReturnStatus other than success (0), that is, the addRequest fails for any reason, the administrative plug-in MUST terminate the BindRequest as specified in section 3.1.5.2 and MUST stop processing the policy assignment event.
7. The administrative plug-in MUST send an LDAP modifyRequest as specified in section 2.2.2. The ipsecOwnersReference, ipsecName, and description parameters for the modifyRequest are the same as the corresponding parameters supplied to this event. If the modifyRequest returns a TaskReturnStatus other than success (0), that is, the modifyRequest fails for any reason, the administrative plug-in MUST terminate the BindRequest as specified in section 3.1.5.2 and MUST stop processing the policy assignment event.
8. The administrative plug-in MUST terminate the LDAP BindRequest as specified section 3.1.5.2.
9. The administrative plug-in MUST invoke the Group Policy extension Update event ([MS-GPOL] section 3.3.4.4, Group Policy Extension Update).

### 3.1.6 Timer Events

None.

### 3.1.7 Other Local Events

None.

## 3.2 IPsec Group Policy Client-Side Plug-in Details

During policy application, this protocol is invoked after the Group Policy: Core Protocol has computed a list of GPOs for which the IPsec client plug-in is to be invoked as specified in [MS-GPOL] section 3.2.5, "Message Processing Events and Sequencing Rules".

### 3.2.1 Abstract Data Model

This section specifies a conceptual model of possible data organization that an implementation can maintain to participate in this protocol. The described organization is provided to facilitate the explanation of how the protocol behaves. This document does not mandate that implementations adhere to this model as long as their external behavior is consistent with that described in this document.

**Local Timer Interval:** Contains the current duration in minutes of the **Local Timer** (section 3.2.2). The initial value is zero.

**RetrievedDomainName:** Contains the domain name retrieved by the DC locator operation, as specified in section 3.2.5.1.

**ADConnectionHandle:** An **ADConnection** structure ([MS-ADTS] section 7.3, "ADConnection Abstract Data Model") of type **ADCONNECTION\_HANDLE** ([MS-DTYP] section 2.2.2, "ADCONNECTION\_HANDLE") that tracks a connection to an Active Directory server.

**Note** An **ADCONNECTION\_HANDLE** object is returned by the **ADConnection** initialization operation specified in section 3.2.5.2.

**LocalWhenChanged:** A copy of the whenChanged attribute from the ipsecPolicy object (see section 2.2.1.1.1) of the assigned policy.

**FilteredGPOList:** A list of new or changed GPOs since this client-side extension was last applied. Filtered GO List is defined in [MS-GPOL] section 3.2.1.5.

### 3.2.2 Timers

**Local Timer:** A local timer controls the time interval at which to check for IPsec policy updates in the IPsec policy container.

### 3.2.3 Initialization

On initialization, the client MUST set the **LocalWhenChanged** ADM element to 0 and then execute the functionality specified in 3.2.6.1. Note that the **whenChanged** attribute in the retrieved policy will never be 0; thus, setting LocalWhenChanged to 0 will trigger the implementation to reread all the policy objects as specified in 3.2.6.1.

## 3.2.4 Higher-Layer Triggered Events

### 3.2.4.1 Processing Group Policy Callbacks

During policy application, this protocol is invoked after the Group Policy: Core Protocol has computed a list of GPOs for which the IPsec client plug-in is to be invoked, as specified in [MS-GPOL] section 3.2.5, "Message Processing Events and Sequencing Rules".

This extension is launched by the Group Policy: Core Protocol by invoking the **Process Group Policy Event** as specified in [MS-GPOL], section 3.2.4.1 and section 3.2.5.1.10.

[MS-GPOL] provides the *New or Changed GPO list*, which is a list of the new or changed GPOs. It also supplies the *Deleted GPO list* and other parameters. The *Deleted GPO list* and all the other parameters supplied to the callback are ignored.

The GPOs that are assigned to the client machine are indicated in the callback in the *New or Changed GPO list*. This list of GPOs MUST be copied to the **FilteredGPOList** ADM element. The client MUST determine the location of the policy that is assigned to the client as specified by sections 3.2.5.1, 3.2.5.2, and 3.2.5.3.

Once the policy location is known, the client MUST read the policy, as specified in sections 3.2.5.1, 3.2.5.2, and 3.2.5.4.

## 3.2.5 Message Processing Events and Sequencing Rules

### 3.2.5.1 Locating a Domain Controller

To locate the domain controller, the client MUST invoke the DC locator operation DsrGetDcName ([MS-NRPC] section 3.5.4.3.3, "DsrGetDcName (Opnum 20)"). For this method, the input parameters are all NULL except for the *Flags* parameter, which MUST have bits B and R set ([MS-NRPC] section 3.5.4.3.1, "DsrGetDcNameEx2 (Opnum 34)").

When the DsrGetDcName method completes, store the value of the **DomainName** member from the returned **DOMAIN\_CONTROLLER\_INFOW** structure in the **RetrievedDomainName** data element.

**Note** The hostname, contained in the **RetrievedDomainName** data element, is resolved to an explicit IP address when connecting to the domain controller in section 3.2.5.2.

If the DsrGetDcName method fails, the client MUST increment the **Local Timer Interval** value (section 3.2.1) by 1, square it, reduce it to 166 if its value is greater than 166, and then set the **Local Timer** to this new value, in minutes. Otherwise, the client MUST retrieve the assigned policy location, name, and description, as specified in section 3.2.5.3.

### 3.2.5.2 Establishing a Connection to the Domain Controller

An ADConnection initialization operation MUST be performed, as specified in [MS-ADTS] section 7.6.1.1, "Initializing an ADConnection". The *TaskInputTargetName* input value MUST be taken from **RetrievedDomainName**, and the *TaskInputPortNumber* value MUST be 389. The resulting ADCONNECTION\_HANDLE object ([MS-DTYP] section 2.2.2, "ADCONNECTION\_HANDLE") MUST be stored in **ADConnectionHandle**.

The following options MUST be set on the ADConnection associated with **ADConnectionHandle**, using the operation specified in [MS-ADTS] section 7.6.1.2, "Setting an LDAP Option on an ADConnection".

- LDAP\_OPT\_PROTOCOL\_VERSION MUST be set to 3.
- LDAP\_OPT\_ENCRYPT MUST be set to TRUE.

- LDAP\_OPT\_SIGN MUST be set to TRUE.

An ADConnection MUST be established using the operation specified in [MS-ADTS] section 7.6.1.3, "Establishing an ADConnection". The *TaskInputADConnection* value MUST be the ADCONNECTION\_HANDLE object ([MS-DTYP] section 2.2.2, "ADCONNECTION\_HANDLE") stored in **ADConnectionHandle**.

Then, the connection handle MUST bind as specified in section 3.1.5.1.

**Note** The hostname, contained in the **RetrievedDomainName** data element, is resolved to an explicit IP address in [MS-ADTS] section 7.6.1.1, "Initializing an ADConnection", and [MS-ADTS] section 7.6.1.3, "Establishing an ADConnection".

### 3.2.5.3 Retrieving the Assigned Policy Location, Name, and Description

The client MUST determine the location of the currently assigned policy by accessing the ipsecOwnersReference attribute, as specified in [MS-ADA1] section 2.330, "Attribute ipsecOwnersReference", of the IPSEC object cn=ipsec,cn=Windows,cn=Microsoft,cn=Machine,<GPO DN>, for the last (highest precedence) GPO of the FilteredGPOList ADM element. The ipsecOwnersReference attribute contains the DN of the ipsecPolicy object that is to be applied to the client machine.

Similarly, the assigned policy name and description MUST be read by retrieving the ipsecName and description values. These values MUST be interpreted as a Directory String (section 2.2.2).

To retrieve the assigned IPsec policy location, name, and description for a GPO, an LDAP operation MUST be performed using the operation specified in [MS-ADTS] section 7.6.1.6, "Performing an LDAP Operation on an ADConnection". The *TaskInputADConnection* value MUST be the ADCONNECTION\_HANDLE object ([MS-DTYP] section 2.2.2, "ADCONNECTION\_HANDLE") stored in **ADConnectionHandle**. The TaskInputRequestMessage MUST contain an LDAP searchRequest message ([RFC2251] [RFC2254]) with the values specified in section 2.2.3.1.

The client MUST first send an LDAP SearchRequest message with the **objectClass** attribute, as specified in 2.2.3.1. If this operation succeeds, then the client MUST send an LDAP SearchRequest message with the **ipsecOwnersReference**, **ipsecName**, and **description** attributes, as specified in 2.2.3.1.

If either LDAP SearchRequest message fails, the local IPsec component MUST be signaled so that it can enter a known-safe state. Otherwise, the client MUST retrieve its assigned policy data (section 3.2.5.4).

### 3.2.5.4 Retrieving the Assigned Policy Data

The IPsec policy data that is currently assigned is specified by the ipsecFilter, ipsecISAKMPPolicy, ipsecNegotiationPolicy, ipsecNFA, and ipsecPolicy entries, as specified in [MS-ADSC] section 2.71, "Class ipsecFilter", [MS-ADSC] section 2.72, "Class ipsecISAKMPPolicy", [MS-ADSC] section 2.73, "Class ipsecNegotiationPolicy", [MS-ADSC] section 2.74, "Class ipsecNFA", and [MS-ADSC] section 2.75, "Class ipsecPolicy", respectively. Additional details are specified in sections 2.2.1.1, 2.2.1.2, 2.2.1.3, 2.2.1.4, and 2.2.1.5. To retrieve the details of the assigned IPsec policy from the IPsec ("System\IP Security") container, an LDAP searchRequest message ([RFC2251] [RFC2254]) with the values specified in section 2.2.3.2 MUST be sent to the domain controller (located in section 3.2.5.1):

If this operation fails, the client MUST increment the **Local Timer Interval** value (section 3.2.1) by 1, square it, reduce it to 166 if its value is greater than 166, and then set the **Local Timer** (section 3.2.2) to this new value, in minutes. Otherwise, it MUST reset the **Local Timer** to the interval specified by the Polling-Interval value that is retrieved as part of the IPsec policy object, as specified in the messages defined in ipsecPolicy Object Attribute Details.

Any retrieved ipsecPolicy object MUST copy its **whenChanged** field (see section 2.2.1.1) to the implementation's **LocalWhenChanged** ADM element, as defined in section 3.2.1.

## 3.2.6 Timer Events

### 3.2.6.1 Local Timer Expiration

When the **Local Timer** (section 3.2.2) expires, the client MUST check for IPsec policy updates in the IPsec policy container.

The client MUST locate the domain controller (section 3.2.5.1), connect to the domain controller (section 3.2.5.2), and retrieve the assigned policy data (section 3.2.5.4) for the assigned ipsecPolicy object. For the newly retrieved ipsecPolicy object, the client MUST compare the whenChanged attribute (section 2.2.1.1.1) against the **LocalWhenChanged** ADM element. If these values are the same, the client MUST reset the timer using the LocalTimerInterval. Otherwise, the client MUST reread all policies for all objects as defined in section 3.2.5.4.

### 3.2.7 Other Local Events

None.

## 4 Protocol Examples

The IT security office of Contoso, Ltd (contoso.com) decides to implement an IPsec-based security solution. On a network that is managed by a central IT department, computers will use the authentication infrastructure and policy distribution mechanism to implement domain and server isolation. Step-by-step details about the configuration and resulting settings can be found in the references [MSFT-ISOLATION-1], [MSFT-ISOLATION-2], and [MSFT-ISOLATION-3].

To configure this functionality, the administrator needs to ensure that computers are members of the domain and are configured with the Group Policy settings to require authentication for incoming communication attempts, to secure data traffic, and optionally, to encrypt data traffic. The security administrator configures this policy format in the IPsec policy administrative user interface.

### 4.1 Administrative Creation/Assignment of Policy

To create and assign the policy, the security administrator uses an IPsec administrative plug-in user interface to configure and make active the required policy. This results in the Group Policy: IPsec Protocol transferring the settings to the IP Security container and the GPO of the client computers that need to participate in the isolation mechanism. In this example, the domain name myDomain.contoso.com is used.

#### 4.1.1 Policy Creation

The protocol messages that occur to create the policy are as follows.

An LDAP addRequest message consists of the following.

- CN=ipsecPolicy{E514E247-80C3-429A-8D69-74BD54FEB31E},CN=IP Security, CN=System, DC=myDomain,DC=contoso,DC=com
- **objectClass** = "ipsecPolicy"
- **ipsecName** = "Domain Isolation Policy"
- **description** = "Policy to secure corporate network traffic"
- **ipsecID** = "{E514E247-80C3-429A-8D69-74BD54FEB31E}"
- **distinguishedName** = "CN=ipsecPolicy{E514E247-80C3-429A-8D69-74BD54FEB31E},CN=IP Security,CN=System,DC=myDomain, DC=contoso,DC=com"
- **ipsecDataType** = "256"
- **ipsecData** = << 25-byte Octet String of IPsec policy data >>

An LDAP addRequest message consists of the following.

- CN=ipsecISAKMPPolicy{12A63239-DFB6-4F7A-9E84-FEA90E81202A},CN=IP Security,CN=System,DC=myDomain,DC=contoso,DC=com
- **objectClass** = "ipsecISAKMPPolicy"
- **ipsecName** = "All Traffic Filter"
- **ipsecID** = "{12A63239-DFB6-4F7A-9E84-FEA90E81202A}"
- **distinguishedName** = "CN=ipsecISAKMPPolicy{12A63239-DFB6-4F7A-9E84-FEA90E81202A},CN=IP Security,CN=System,DC=myDomain, DC=contoso,DC=com"

- **ipsecOwnersReference** = "CN=ipsecPolicy{E514E247-80C3-429A-8D69-74BD54FEB31E},CN=IP Security,CN=System,DC=myDomain, DC=contoso,DC=com"
- **ipsecDataType** = "256"
- **ipsecData** = << 293-byte Octet String of IPsec (ISAKMP) policy data >>

An LDAP addRequest message consists of the following.

- ipsecNFA{116CA92D-D536-4A44-BDCE-17D8363ED949},CN=IP Security, CN=System,DC=myDomain,DC=contoso,DC=com
- **objectClass** = "ipsecNFA"
- **ipsecName** = "All Traffic Filters"
- **description** = "Me to Any Filters for traffic protection"
- **ipsecID** = "{116CA92D-D536-4A44-BDCE-17D8363ED949}"
- **distinguishedName** = "ipsecNFA{116CA92D-D536-4A44-BDCE-17D8363ED949},CN=IP Security,CN=System, DC=myDomain,DC=contoso,DC=com"
- **ipsecOwnersReference** = "CN=ipsecPolicy{E514E247-80C3-429A-8D69-74BD54FEB31E},CN=IP Security,CN=System,DC=myDomain, DC=contoso,DC=com"
- **ipsecDataType** = "256"
- **ipsecData** = << 172-byte Octet String of IPsec (NFA) policy data >>

An LDAP addRequest message consists of the following.

- ipsecNegotiationPolicy{72385233-70FA-11D1-864C-14A300000000},CN=IP Security, CN=System, DC=myDomain,DC=contoso,DC=com
- **objectClass** = "ipsecNegotiationPolicy"
- **ipsecName** = "All Traffic Filter"
- **description** = "Secure the traffic with ESP(3DES)"
- **ipsecID** = "{72385233-70FA-11D1-864C-14A300000000}"
- **distinguishedName** = "ipsecNegotiationPolicy{72385233-70FA-11D1-864C-14A300000000},CN=IP Security,CN=System, DC=myDomain,DC=contoso,DC=com"
- **ipsecOwnersReference** = "CN= ipsecNFA{116CA92D-D536-4A44-BDCE-17D8363ED949},CN=IP Security,CN=System, DC=myDomain,DC=contoso,DC=com"
- **ipsecNegotiationPolicyAction** = "{3F91A819-7647-11D1-864D-D46A00000000}"
- **ipsecNegotiationPolicyType** = "{62F49E10-6C37-11D1-864C-14A300000000}"
- **ipsecDataType** = "256"
- **ipsecData** = << 43-byte Octet String of IPsec (Negotiation) policy data >>

An LDAP addRequest message consists of the following.

- ipsecFilter{2FE2FD79-0389-4D6C-8794-55C4D444DB31},CN=IP Security, CN=System, DC=myDomain,DC=contoso,DC=com
- **objectClass** = "ipsecFilter"



- **ipsecName** = "All Traffic Filter"
- **description** = "Protect all traffic to my servers"
- **ipsecID** = "{2FE2FD79-0389-4D6C-8794-55C4D444DB31}"
- **distinguishedName** = "ipsecFilter{2FE2FD79-0389-4D6C-8794-55C4D444DB31},CN=IP Security,CN=System, DC=myDomain,DC=contoso,DC=com"
- **ipsecOwnersReference** = "CN= ipsecNFA{116CA92D-D536-4A44-BDCE-17D8363ED949},CN=IP Security,CN=System, DC=myDomain,DC=contoso,DC=com"
- **ipsecDataType** = "256"
- **ipsecData** = << 108-byte Octet String of IPsec (Filter) policy data >>

An LDAP modifyRequest (with the replace operation) message consists of the following:

- CN=ipsecPolicy{E514E247-80C3-429A-8D69-74BD54FEB31E},CN=IP Security, CN=System, DC=myDomain,DC=contoso,DC=com
- **ipsecISAKMPReference**= "CN=ipsecISAKMPPolicy{12A63239-DFB6-4f7A-9E84-FEA90E81202A},CN=IP Security,CN=System,DC=myDomain,DC=contoso,DC=com"
- **ipsecNFAReference**= " CN=ipsecNFA{116CA92D-D536-4A44-BDCE-17D8363ED949},CN=IP Security, CN=System,DC=myDomain,DC=contoso,DC=com "

An LDAP modifyRequest (with the replace operation) message consists of the following:

- CN=ipsecNFA{116CA92D-D536-4A44-BDCE-17D8363ED949},CN=IP Security, CN=System,DC=myDomain,DC=contoso,DC=com
- **ipsecNegotiationPolicyReference**= "CN= ipsecNegotiationPolicy{72385233-70FA-11D1-864C-14A300000000},CN=IP Security, CN=System, DC=myDomain,DC=contoso,DC=com"
- **ipsecFilterReference**= "CN=ipsecFilter{2FE2FD79-0389-4D6C-8794-55C4D444DB31},CN=IP Security, CN=System, DC=myDomain,DC=contoso,DC=com"

#### 4.1.2 Policy Assignment

The protocol message that occurs to assign the policy is as follows:

An LDAP addRequest message consists of the following:

- IPSEC,CN=Windows,CN=Microsoft,CN=Machine,CN={2C4E2FD79-0E89-4D6C-8794-55C4D444DB31},CN=Policies,CN=System,DC=myDomain, DC=contoso,DC=com

The objectClass = ipsecPolicy.

An LDAP modifyRequest message consists of the following:

- IPSEC,CN=Windows,CN=Microsoft,CN=Machine,CN={2C4E2FD79-0E89-4D6C-8794-55C4D444DB31},CN=Policies,CN=System,DC=myDomain, DC=contoso,DC=com
- **ipsecName** = "Assigned IPsec Policy v1.2.1.2 [assigned July 2006]"
- **description** = "Active Policy to Protect the network"
- **ownersReference** = "CN=ipsecPolicy{E514E247-80C3-429A-8D69-74BD54FEB31E},CN=IP Security,CN=System,DC=myDomain, DC=contoso,DC=com"

## 4.2 Client Retrieval of Policy

On client machines that are members of the GPO, the Group Policy protocol client subsequently signals the IPsec client-side plug-in, as specified in [MS-GPOL] section 3.2.5, "Message Processing Events and Sequencing Rules", that an IPsec policy has been activated. The policy is retrieved by using the Group Policy: IPsec Protocol and is supplied to the local IPsec/IKE component to enact the required policy.

### 4.2.1 Retrieving the Assigned Policy Name, Description, and Location

The protocol exchange that occurs to retrieve the assigned policy is as follows:

LDAP SearchRequest (with the filter "objectClass=\*") message, as specified in section 3.2.5.3:

- **Location:** IPSEC,CN=Windows,CN=Microsoft,CN=Machine,CN={2C4E2FD79-0E89-4D6C-8794-55C4D444DB31},CN=Policies,CN=System,DC=myDomain, DC=contoso,DC=com
- **Attributes:** None

On success:

LDAP SearchRequest (with the filter "objectClass=\*") message, as specified in section 3.2.5.3:

- **Location:** IPSEC,CN=Windows,CN=Microsoft,CN=Machine,CN={2C4E2FD79-0E89-4D6C-8794-55C4D444DB31},CN=Policies,CN=System,DC=myDomain, DC=contoso,DC=com
- **Attributes:** ipsecName, description, ownersReference

The data returned is as follows:

- **ipsecName** = "Assigned IPsec Policy v1.2.1.2 [assigned July 2006]"
- **description** = "Active Policy to Protect the network"
- **ownersReference** = "CN=ipsecPolicy{E514E247-80C3-429A-8D69-74BD54FEB31E},CN=IP Security,CN=System,DC=myDomain, DC=contoso,DC=com"

### 4.2.2 Retrieving the Assigned Policy Data

The protocol messages that occur to retrieve the assigned policy data are as follows:

LDAP searchRequest message, as specified in ipsecPolicy Object Attribute Details (section 2.2.1.1):

- **Location:** CN=IP Security, CN=System, DC=myDomain,DC=contoso,DC=com
- **Filter:** (&(objectclass=ipsecPolicy)(cn=ipsecPolicy{E514E247-80C3-429A-8D69-74BD54FEB31E}))
- **Attributes:** ipsecName, description, ipsecID, distinguishedName, ipsecISAKMPReference, ipsecNFARReference, ipsecDataType, ipsecData

The data returned is as follows:

- **ipsecName** = "Domain Isolation Policy"
- **description** = "Policy to secure corporate network traffic"
- **ipsecID** = "{E514E247-80C3-429A-8D69-74BD54FEB31E}"
- **distinguishedName** = "CN=ipsecPolicy{E514E247-80C3-429A-8D69-74BD54FEB31E},CN=IP Security,CN=System,DC=myDomain, DC=contoso,DC=com"

- **ipsecISAKMPReference** = "ipsecISAKMPPolicy{12A63239-DFB6-4F7A-9E84-FEA90E81202A},CN=IP Security,CN=System,DC=myDomain, DC=contoso,DC=com"
- **ipsecNFAReference** = ipsecNFA{116CA92D-D536-4A44-BDCE-17D8363ED949},CN=IP Security,CN=System, DC=myDomain,DC=contoso,DC=com"
- **ipsecDataType** = "256"
- **ipsecData** = << 25-byte Octet String of IPsec policy data >>

LDAP searchRequest message, as specified in ipsecISAKMPPolicy Object Attribute Details (section 2.2.1.2):

- **Location:** CN=IP Security,CN=System,DC=myDomain,DC=contoso,DC=com
- **Filter:** (&(objectclass=ipsecISAKMPPolicy)(cn=ipsecISAKMPPolicy{12A63239-DFB6-4f7A-9E84-FEA90E81202A}))
- **Attributes:** ipsecName, ipsecID, distinguishedName, ipsecOwnersReference, ipsecDataType, ipsecData

The data returned is as follows:

- **ipsecName** = ""
- **ipsecID** = "{12A63239-DFB6-4F7A-9E84-FEA90E81202A}"
- **distinguishedName** = "CN=ipsecISAKMPPolicy{12A63239-DFB6-4F7A-9E84-FEA90E81202A},CN=IP Security,CN=System,DC=myDomain, DC=contoso,DC=com "
- **ipsecOwnersReference** = "CN=ipsecPolicy{E514E247-80C3-429A-8D69-74BD54FEB31E},CN=IP Security,CN=System,DC=myDomain, DC=contoso,DC=com"
- **ipsecDataType** = "256"
- **ipsecData** = << 293-byte Octet String of IPsec (ISAKMP) policy data >>

LDAP searchRequest message, as specified in ipsecNFA Object Attribute Details (section 2.2.1.3):

- **Location:** CN=IP Security,CN=System,DC=myDomain,DC=contoso,DC=com
- **Filter:** (&(objectclass=ipsecNFA)(cn=ipsecNFA{116CA92D-D536-4A44-BDCE-17D8363ED949}))
- **Attributes:** ipsecName, description, ipsecID, distinguishedName, ipsecOwnersReference, ipsecNegotiationPolicyReference, ipsecDataType, ipsecData

The data returned is as follows:

- **ipsecName** = "All Traffic Filters"
- **description** = "Me to Any Filters for traffic protection"
- **ipsecID** = "{116CA92D-D536-4A44-BDCE-17D8363ED949}"
- **distinguishedName** = "ipsecNFA{116CA92D-D536-4A44-BDCE-17D8363ED949},CN=IP Security,CN=System, DC=myDomain,DC=contoso,DC=com"
- **ipsecOwnersReference** = "CN=ipsecPolicy{E514E247-80C3-429A-8D69-74BD54FEB31E},CN=IP Security,CN=System,DC=myDomain, DC=contoso,DC=com"
- **ipsecFilterReference** = "CN=ipsecFilter{2FE2FD79-0389-4D6C-8794-55C4D444DB31},CN=IP Security,CN=System,DC=myDomain, DC=contoso,DC=com"

- **ipsecNegotiationPolicyReference** = "CN=ipsecNegotiationPolicy{72385233-70FA-11D1-864C-14A300000000},CN=IP Security,CN=System, DC=myDomain,DC=contoso,DC=com"
- **ipsecDataType** = "256"
- **ipsecData** = << 172-byte Octet String of IPsec (NFA) policy data >>

LDAP searchRequest message, as specified in ipsecNegotiationPolicy Object Attribute Details (section 2.2.1.4):

- **Location:** CN=IP Security,CN=System,DC=myDomain,DC=contoso,DC=com
- **Filter:** (&(objectclass=ipsecNegotiationPolicy)(cn= ipsecNegotiationPolicy{72385233-70FA-11D1-864C-14A300000000}))
- **Attributes:** ipsecName, description, ipsecID, distinguishedName, ipsecOwnersReference, ipsecNegotiationPolicyAction, ipsecNegotiationPolicyType, ipsecDataType, ipsecData

The data returned is as follows:

- **ipsecName** = ""
- **description** = "Secure the traffic with ESP(3DES)"
- **ipsecID** = "{72385233-70FA-11D1-864C-14A300000000}"
- **distinguishedName** = "ipsecNegotiationPolicy{72385233-70FA-11D1-864C-14A300000000},CN=IP Security,CN=System, DC=myDomain,DC=contoso,DC=com"
- **ipsecOwnersReference** = "CN= ipsecNFA{116CA92D-D536-4A44-BDCE-17D8363ED949},CN=IP Security,CN=System, DC=myDomain,DC=contoso,DC=com"
- **ipsecNegotiationPolicyAction** = "{8A171DD3-77E3-11D1-8659-A04F00000000} "
- **ipsecNegotiationPolicyType** = "{62F49E10-6C37-11D1-864C-14A300000000}"
- **ipsecDataType** = "256"
- **ipsecData** = << 43-byte Octet String of IPsec (Negotiation) policy data >>

LDAP searchRequest message, as specified in ipsecFilter Object Attribute Details (section 2.2.1.5):

- **Location:** CN=IP Security,CN=System,DC=myDomain,DC=contoso,DC=com
- **Filter:** (&(objectclass=ipsecFilter)(cn=ipsecFilter{2FE2FD79-0389-4D6C-8794-55C4D444DB31}))
- **Attributes:** ipsecName, description, ipsecID, distinguishedName, ipsecOwnersReference, ipsecDataType, ipsecData

The data returned is as follows:

- **ipsecName** = "All Traffic Filter"
- **description** = "Protect all traffic to my servers"
- **ipsecID** = "{2FE2FD79-0389-4D6C-8794-55C4D444DB31}"
- **distinguishedName** = "ipsecFilter{2FE2FD79-0389-4D6C-8794-55C4D444DB31},CN=IP Security,CN=System, DC=myDomain,DC=contoso,DC=com"
- **ipsecOwnersReference** = "CN= ipsecNFA{116CA92D-D536-4A44-BDCE-17D8363ED949},CN=IP Security,CN=System, DC=myDomain,DC=contoso,DC=com"

- **ipsecDataType** = "256"
- **ipsecData** = << 108-byte Octet String of IPsec (Filter) policy data >>

## 5 Security

### 5.1 Security Considerations for Implementers

The transmission of the IPsec configuration data can present a risk of disclosing the assets that the IPsec policy is being used to protect. Of particular concern is the transmission of a pre-shared key (in plain text), as specified in ipsecNFA Object Attribute Details (section 2.2.1.3), and whether the ability to determine the security controls allows an attacker to analyze the policy for weaknesses and organizational data. As such, implementers are advised to provide data integrity and data confidentiality for this protocol.

### 5.2 Index of Security Parameters

This protocol does not explicitly control the security parameters that are used to protect the data; however, it does configure the IPsec component, which is a group of security parameter settings.

Security parameter	Section
IKE MM Diffie-Hellman groups	ipsecISAKMPPolicy{GUID} Object Attribute Descriptions (section 2.2.1.2.1)
IKE MM encryption algorithms	ipsecISAKMPPolicy{GUID} Object Attribute Descriptions (section 2.2.1.2.1)
IKE MM integrity algorithms	ipsecISAKMPPolicy{GUID} Object Attribute Descriptions (section 2.2.1.2.1)
IKE MM key lifetimes	ipsecISAKMPPolicy{GUID} Object Attribute Descriptions (section 2.2.1.2.1)
IKE authentication method (PSK, X.509 certificate, Kerberos)	ipsecNFA{GUID} Object Description (section 2.2.1.3.1)
Traffic protection to enact (permit, block, and secure with IPsec)	ipsecNegotiationPolicy Object Attribute Details (section 2.2.1.4)
IPsec QM key lifetimes	ipsecNegotiationPolicy{GUID} Object Description (section 2.2.1.4.1)
IPsec framing method (ESP or AH)	ipsecNegotiationPolicy{GUID} Object Description (section 2.2.1.4.1)
IPsec encryption algorithms	ipsecNegotiationPolicy{GUID} Object Description (section 2.2.1.4.1)
IPsec integrity algorithms	ipsecNegotiationPolicy{GUID} Object Description (section 2.2.1.4.1)

## 6 (Updated Section) Appendix A: Product Behavior

The information in this specification is applicable to the following Microsoft products or supplemental software. References to product versions include updates to those products.

- Windows 2000 operating system
- Windows XP operating system
- Windows XP operating system Service Pack 2 (SP2)
- Windows Server 2003 operating system
- Windows Vista operating system
- Windows Server 2008 operating system
- Windows 7 operating system
- Windows Server 2008 R2 operating system
- Windows 8 operating system
- Windows Server 2012 operating system
- Windows 8.1 operating system
- Windows Server 2012 R2 operating system
- Windows 10 operating system
- Windows Server 2016 operating system
- Windows Server operating system
- Windows Server 2019 operating system
- Windows Server 2022 operating system

### ▪ Windows 11 operating system

Exceptions, if any, are noted in this section. If an update version, service pack or Knowledge Base (KB) number appears with a product name, the behavior changed in that update. The new behavior also applies to subsequent updates unless otherwise specified. If a product edition appears with the product version, behavior is different in that product edition.

Unless otherwise specified, any statement of optional behavior in this specification that is prescribed using the terms "SHOULD" or "SHOULD NOT" implies product behavior in accordance with the SHOULD or SHOULD NOT prescription. Unless otherwise specified, the term "MAY" implies that the product does not follow the prescription.

<1> Section 2.2.1.2.1: The **ipsecName** is not used in Windows, and its value as purely descriptive.

<2> Section 2.2.1.2.1: The **New-DH-1** field is not implemented in Windows 2000 and Windows XP.

<3> Section 2.2.1.2.1: The **New-DH-2** field is not implemented in Windows 2000 and Windows XP.

<4> Section 2.2.1.2.1: The **New-DH-3** field is not implemented in Windows 2000 and Windows XP.

<5> Section 2.2.1.2.1: The **New-DH-4** field is not implemented in Windows 2000 and Windows XP.

<6> Section 2.2.1.3.1: Except for Windows Server 2003 and Windows XP SP2, Windows honors the settings in the additional data. Windows Server 2003 and Windows XP SP2 read only up to the value specified in the data length; the additional data is ignored.

<7> Section 2.2.1.3.1: In Windows, the name is in the format "OU=Copyright (c) 1997 Microsoft Corp., OU=Microsoft Corporation,CN=Microsoft Root Authority".

<8> Section 2.2.1.3.1: IPv6 address support for Tunnel-Address, Source-Address, and Destination-Address is not implemented in Windows 2000, Windows XP, and Windows Server 2003.

<9> Section 2.2.1.3.1: The **Alt-Auth-Method-Id1** field is not implemented in Windows 2000, Windows XP, and Windows Server 2003.

<10> Section 2.2.1.3.1: The **Alt-Auth-Num-Methods-Count** field is not implemented in Windows 2000, Windows XP, and Windows Server 2003.

<11> Section 2.2.1.3.1: The **Alt-Auth-Method-Data** field is not implemented in Windows 2000, Windows XP, and Windows Server 2003.

<12> Section 2.2.1.3.1: The **Alt-Auth-Type** field is not implemented in Windows 2000, Windows XP, and Windows Server 2003.

<13> Section 2.2.1.3.1: The **Alt-Auth-Method-Length** field is not implemented in Windows 2000, Windows XP, and Windows Server 2003.

<14> Section 2.2.1.3.1: The **Alt-Auth-Method-Value** field is not implemented in Windows 2000, Windows XP, and Windows Server 2003.

<15> Section 2.2.1.3.1: In Windows, the name is in the format "OU=Copyright (c) 1997 Microsoft Corp., OU=Microsoft Corporation,CN=Microsoft Root Authority".

<16> Section 2.2.1.3.1: The **Alt-Auth-Method-Id2** field is not implemented in Windows 2000, Windows XP, and Windows Server 2003.

<17> Section 2.2.1.3.1: The **Alt-Auth-Method-Flags** field is not implemented in Windows 2000, Windows XP, and Windows Server 2003.

<18> Section 2.2.1.3.1: The (Optional) **IPv6-Tunnel-Mode-ID** field is not implemented in Windows 2000, Windows XP, and Windows Server 2003.

<19> Section 2.2.1.3.1: The (Optional) **IPv6-Tunnel-Mode-Address** field is not implemented in Windows 2000, Windows XP, and Windows Server 2003.

<20> Section 2.2.1.4.1: **ipsecName** is not used by Windows in its implementation. Windows considers this value as purely descriptive.

<21> Section 2.2.1.5.1: On Windows XP SP2 and Windows Server 2003, this field is always one byte less than the size of the following data encoded as an octet stream.

<22> Section 2.2.1.5.1: The **Legacy-Special-Filter** special-filter is not implemented in Windows 2000 and Windows XP.

<23> Section 2.2.1.5.1: The **Filter-Policy-ID2** field with curly braced GUID string {35FECD3D-AE29-4373-8A6A-C5D8FAB2FB08} is not implemented in Windows 2000, Windows XP, and Windows Server 2003.

<24> Section 2.2.1.5.1: The **Source-Address-Data** field is not implemented in Windows 2000, Windows XP, and Windows Server 2003.

<25> Section 2.2.1.5.1: The **Destination-Address-Data** field is not implemented in Windows 2000, Windows XP, and Windows Server 2003.



<26> Section 2.2.1.5.1: The **Source-Port-Data** field is not implemented in Windows 2000, Windows XP, and Windows Server 2003.

<27> Section 2.2.1.5.1: The **Destination-Port-Data** field is not implemented in Windows 2000, Windows XP, and Windows Server 2003.

<28> Section 2.2.1.5.1: The **Filter-Protocol** field is not implemented in Windows 2000, Windows XP, and Windows Server 2003.

<29> Section 2.2.1.5.1: The **Filter-Flags** field is not implemented in Windows 2000, Windows XP, and Windows Server 2003.

<30> Section 3.1.5.7: Windows does not update the **ipsecOwnersReference**, **description**, or **ipsecName** field.

## 7 Change Tracking

This section identifies changes that were made to this document since the last release. Changes are classified as Major, Minor, or None.

The revision class **Major** means that the technical content in the document was significantly revised. Major changes affect protocol interoperability or implementation. Examples of major changes are:

- A document revision that incorporates changes to interoperability requirements.
- A document revision that captures changes to protocol functionality.

The revision class **Minor** means that the meaning of the technical content was clarified. Minor changes do not affect protocol interoperability or implementation. Examples of minor changes are updates to clarify ambiguity at the sentence, paragraph, or table level.

The revision class **None** means that no new technical changes were introduced. Minor editorial and formatting changes may have been made, but the relevant technical content is identical to the last released version.

The changes made to this document are listed in the following table. For more information, please contact [dochelp@microsoft.com](mailto:dochelp@microsoft.com).

Section	Description	Revision class
6 Appendix A: Product Behavior	Updated for this version of Windows Client.	Major

## 8 Index

### A

- Abstract data model
  - administrative 61
  - client 67
- Administrative
  - abstract data model 61
  - higher-layer triggered events 61
  - initialization 61
  - message processing 62
  - policy creation/assignment example 71
  - sequencing rules 62
  - timer events 67
  - timers 61
- Applicability 14

### C

- Capability negotiation 14
- Change tracking 82
- Client

- abstract data model 67
- higher-layer triggered events 68
- initialization 67
- message processing 68
- overview 67
- policy retrieval example 74
- sequencing rules 68
- timer events 70
- timers 67

### D

- Data model - abstract
  - administrative 61
  - client 67
- Directory service schema elements 59

### E

- Elements - directory service schema 59
- Examples
  - administrative policy creation/assignment 71
  - client policy retrieval 74
  - overview 71

### F

- Fields - vendor-extensible 14

### G

- Glossary 6

### H

- Higher-layer triggered events
  - administrative 61
  - client 68

### I

- Implementer - security considerations 78
- Implementers - security considerations 78
- Index of security parameters 78
- Informative references 9
- Initialization
  - administrative 61
  - client 67
- Introduction 6
- IPsec Policy Assignment message 56
- IPsec Policy Creation/Modification message 16
- IPsec Policy Retrieval message 57
- ipsecFilter packet 45
- ipsecISAKMPPolicy packet 24
- ipsecNegotiationPolicy packet 39
- ipsecNFA packet 32
- ipsecPolicy packet 21

## **M**

- Message processing
  - administrative 62
  - client 68
- Messages
  - IPsec Policy Assignment 56
  - IPsec Policy Creation/Modification 16
  - IPsec Policy Retrieval 57
  - syntax 16
  - transport 16

## **N**

- Normative references 8

## **O**

- Overview (synopsis) 10

## **P**

- Parameters - security 78
- Parameters - security index 78
- Policy
  - administrative creation/assignment example 71
  - assignment 56
  - client retrieval example 74
  - creation and modification 16
- Preconditions 14
- Prerequisites 14
- Product behavior 79

## **R**

- References 8
  - informative 9
  - normative 8
- Relationship to other protocols 13

## **S**

- Schema elements - directory service 59
- Security 78
  - implementer considerations 78
  - parameter index 78

Sequencing rules  
  administrative 62  
  client 68  
Standards assignments 15  
Syntax - message 16

## **T**

Timer events  
  administrative 67  
  client 70  
Timers  
  administrative 61  
  client 67  
Tracking changes 82  
Transport 16  
Transport - message 16  
Triggered events - higher-layer  
  administrative 61  
  client 68

## **V**

Vendor-extensible fields 14  
Versioning 14